

Instruction Manual

VARIABLE SPEED MINI LATHE

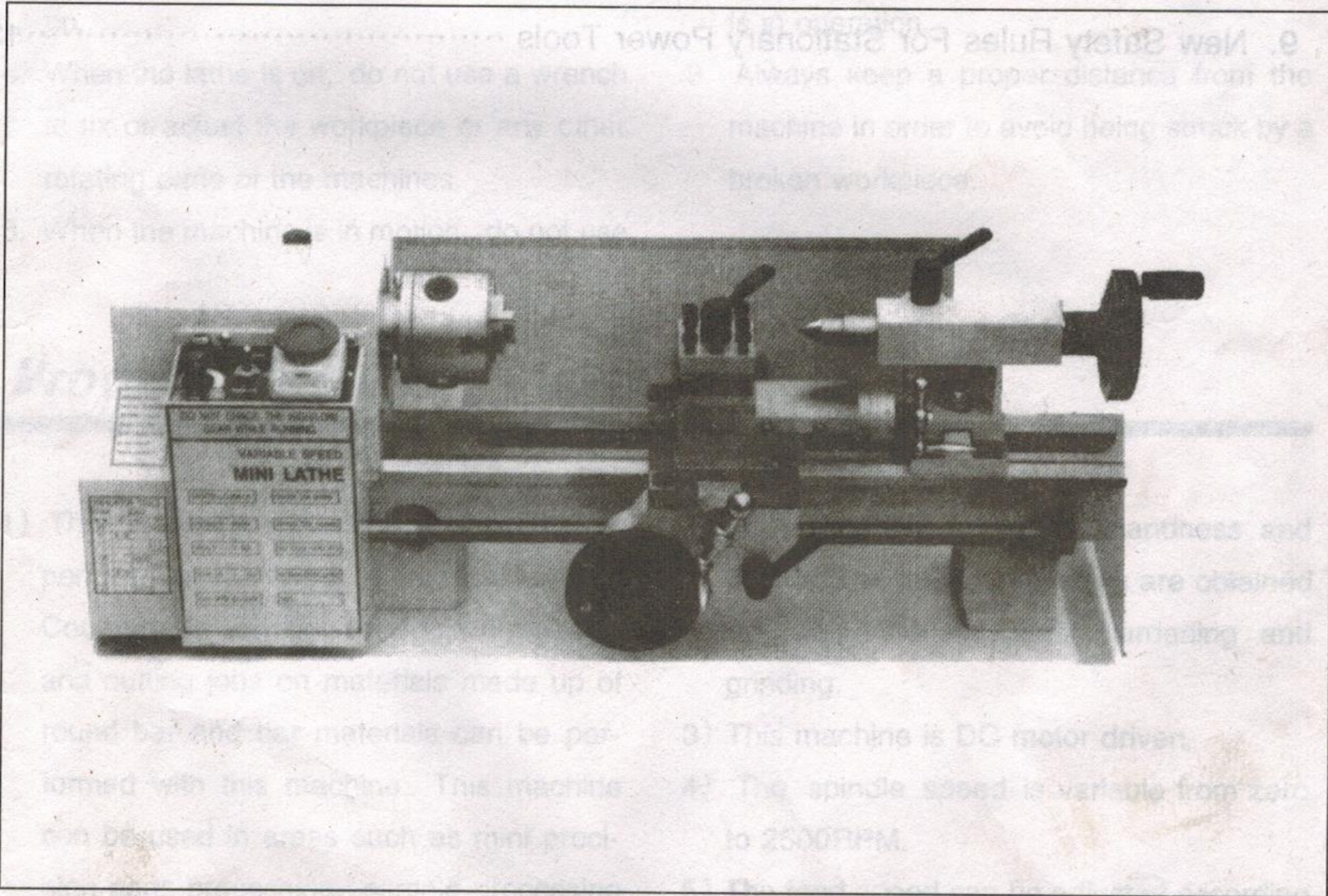

Before Using Be Sure To Read This Manual.

This Machine is Suitable To Use Only From 12°C ~ 35°C(53.6°F~95°F).

Content

1. Safety Rules For Lathe	2
2. Product Features	2
3. Specifications	3
4. Unpacking And Major Parts	3
5. Grounding And Insulation	5
6. Adjustment And Preparation	5
7. Operation And Replacement	7
8. Assembly Diagram And Parts List	10
9. New Safety Rules For Stationary Power Tools	13



Before Using Be Sure To Read This Manual.
This Machine is Suitable To Use Only From 120 - 250°C (250°F - 500°F)

Safety Rules For Lathe

1. Before you turn on the motor, be sure that you have put in suitable lubrication according to manual's instruction. Also check carefully to see all the tool workpieces etc. are in proper positions.
2. Always use your hand to dismount the chuck or the lathe's face plate. Do not use power tools.
3. After installation of the chuck, remove the wrenches and tools in order not to cause any accidents when the machine is turned on.
4. When the lathe is on, do not use a wrench to fix or adjust the workpiece or any other rotating parts of the machines.
5. When the machine is in motion, do not use any instruments to measure the machine, nor test the sharpness of the cutter with your hand.
6. Do not use too large a tool cutter to do your feeding with too large a workpiece. This will easily cause an accident because of a broken workpiece.
7. Always use the right tools and stand at the proper position when performing your work.
8. Do not change the gear when the machine is in operation.
9. Always keep a proper distance from the machine in order to avoid being struck by a broken workpiece.

Product Features

- 1) This precision mini lathe is designed to perform various types of processing jobs. Counterface turning, drilling, threading, and cutting jobs on materials made up of round bar and bar materials can be performed with this machine. This machine can be used in areas such as mini precision parts processing, sample processing and modeling works.
 - 2) The lathe bed is made of high grade iron.
 - 3) This machine is DC motor driven.
 - 4) The spindle speed is variable from zero to 2500RPM.
 - 5) The feed speed can be adjusted according to the requirements of different workpieces.
- The rigidity of lathe, the handness and accuracy of the v – slideways are obtained by raw materials, heat hardening and grinding.

Specifications

Model	CQ0618 - 300/CQ0618 - 200	
Distance Between Centers	300mm/200mm	12"/8"
Swing over bed	180mm	7"
Spindle Taper	MT3	
Tailstock Taper	MT2	
Chuck Diameter	80mm	3.15"
Spindle Bore	20mm	0.79"
Cross Slide Travel	65mm	2.56"
Top Slide Travel	35mm	1.38"
Range of imperial threads	12 - 52T.P.I	
Spindle Accuracy	0.01mm	0.0004"
Spindle speed	0 - 2500RPM Infinitely Variable	
Power of Motor	400w Single Phase	0.53HP
Vol./Freq.	230V/50Hz or 120V/60Hz (± 10%)	
Net Weight	38KG/36KG	84b/80b
Packing Dimensions	760 × 305 × 315/660 × 325 × 315mm	30 × 12 × 12"/26 × 12 × 12.4"

Unpacking And Major Parts

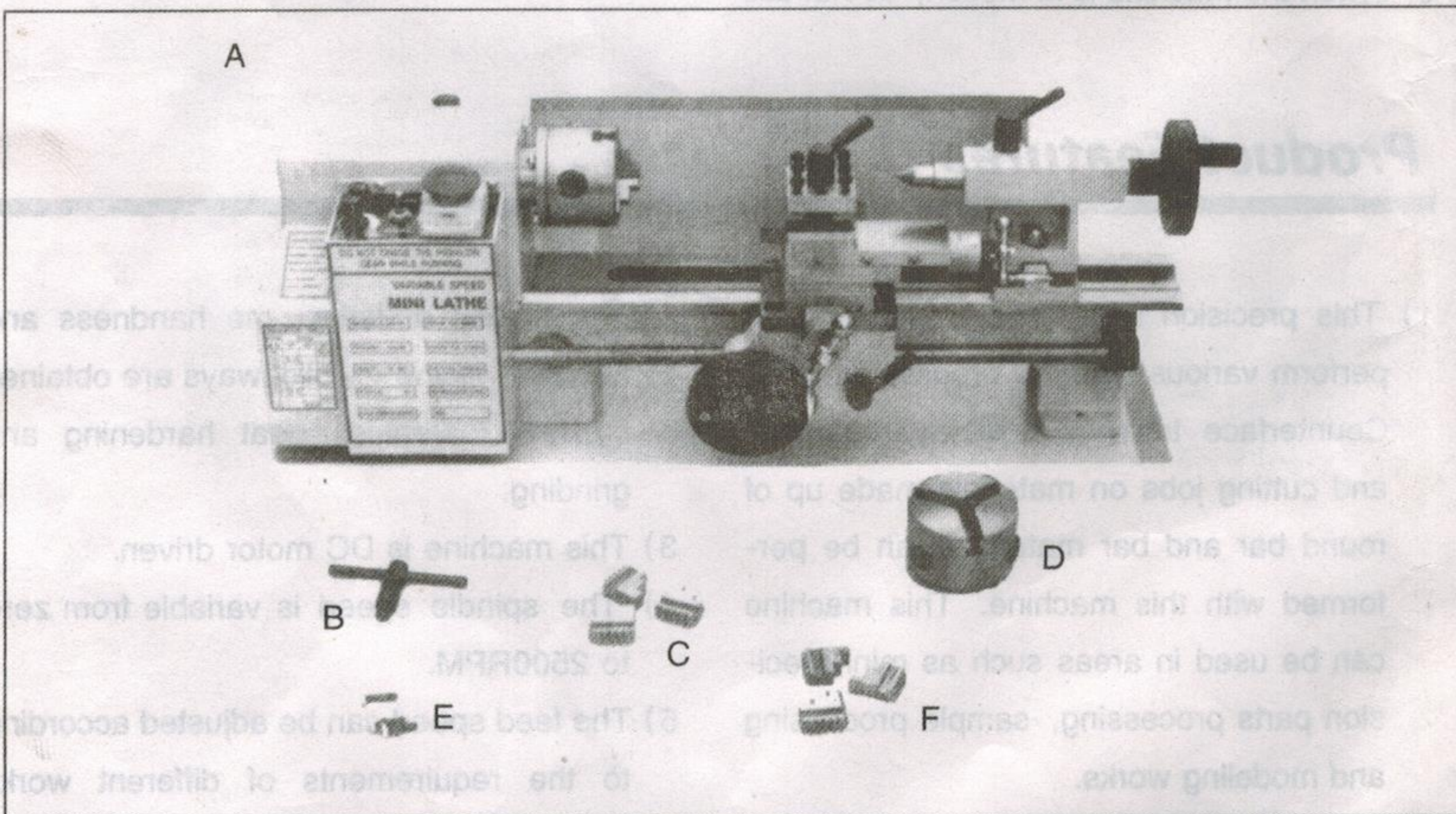

Fig. 1 Contents Of The Carton
 Carefully unpack the Mini Lathe and check all items. Figure 1 illustrates contents of the carton. Do not discard any packing material until the Mini Lathe is fully assembled and operational.

- A. Lathe
- B. Chuck key
- C. External Jaws
- D. Chuck
- E. Chuck set screws
- F. Internal Jaws

The
 Fig.
 1. C
 6. C
 7. C
 8. T
 9. F
 10.
 11.
 12.

The major parts of the lathe are shown in Fig. 2 and in Fig. 3.

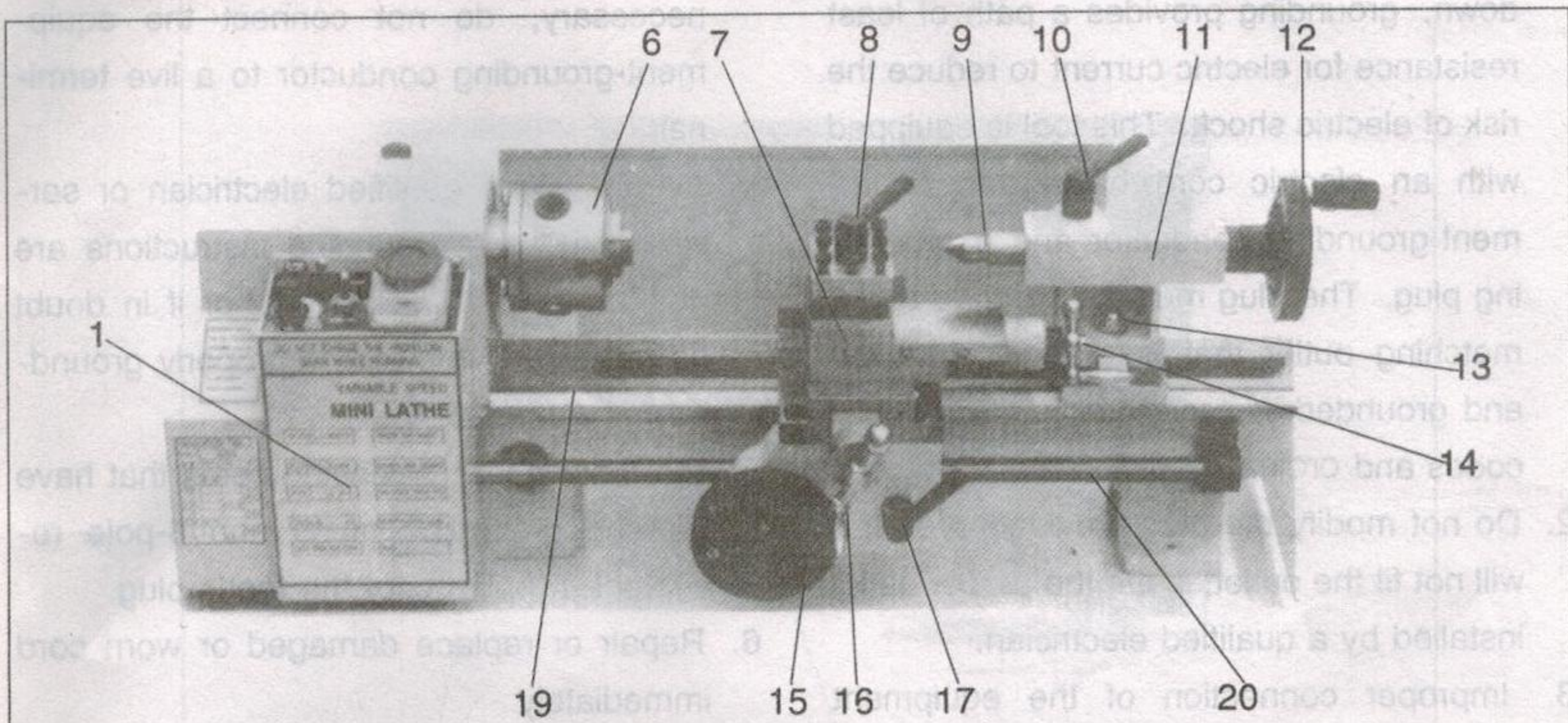

Fig. 2 Front View Of The Lathe

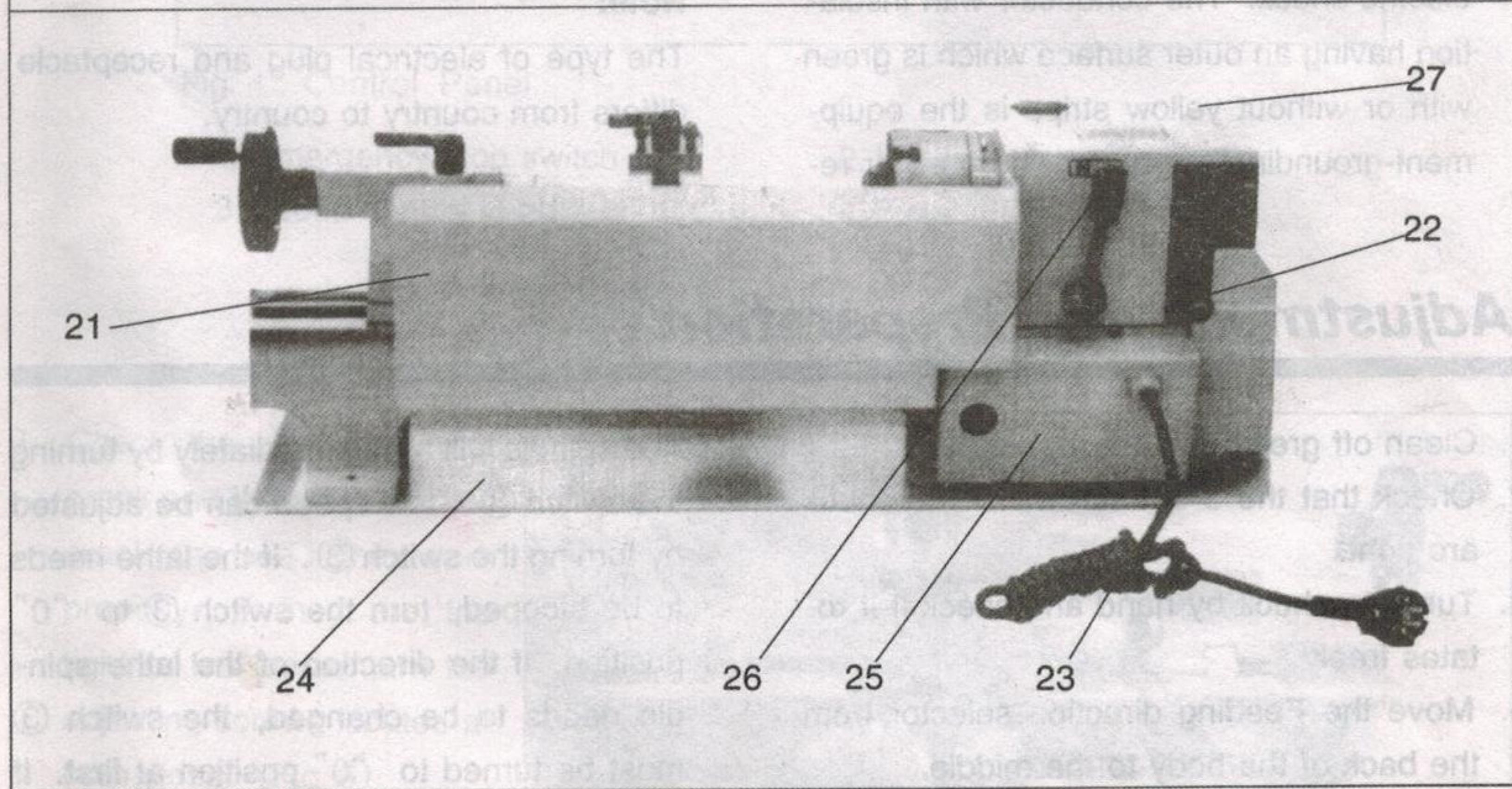

Fig. 3 Back View Of The Lathe

- | | | |
|--------------------------------|------------------------------|--------------------------------|
| 1. Control box (see page 4) | handwheel | 21. Rear splash guard |
| 6. Chuck | 13. Tailstock set screw | 22. Feeding direction selector |
| 7. Compound rest | 14. Compound rest crank | 23. Power cord |
| 8. Tool post | 15. Feeding control wheel | 24. Chip tray |
| 9. Fixed center | 16. Cross feeding crank | 25. Motor cover |
| 10. Tailstock quill fix holder | 17. Automatic feeding handle | 26. H/L Gear shift lever |
| 11. Tailstock | 19. Bed way | 27. End cover |
| 12. Tailstock quill adjust | 20. Lead screw | |

Grounding And Insulation

1. In the event of a malfunction or breakdown, grounding provides a path of least resistance for electric current to reduce the risk of electric shock. This tool is equipped with an electric cord having an equipment-grounding conductor and a grounding plug. The plug must be plugged into a matching outlet that is properly installed and grounded in accordance with all local codes and ordinances.
2. Do not modify the plug provided even if it will not fit the outlet, have the proper outlet installed by a qualified electrician.
3. Improper connection of the equipment grounding conductor can result in a risk of electric shock. The conductor with insulation having an outer surface which is green with or without yellow stripe is the equipment-grounding conductor. If repair or replacement of the electric cord or plug is necessary, do not connect the equipment-grounding conductor to a live terminal.
4. Check with a qualified electrician or serviceman if the grounding instructions are not completely understood, or if in doubt as to whether the tool is properly grounded.
5. Use only 3-wire extension cords that have 3-prong grounding plugs and 3-pole receptacles that accept the tool's plug.
6. Repair or replace damaged or worn cord immediately.

Note:

The type of electrical plug and receptacle differs from country to country.

Adjustment And Preparation

1. Clean off grease on the machine.
2. Check that the 3 set screws of the chuck are tight.
3. Turn the chuck by hand and check if it rotates freely.
4. Move the Feeding direction selector from the back of the body to the middle.
5. First shut off the switch ①. Adjust the switch ③ by turning to "0" position and turn the switch ② to STOP position. If the lathe needs to be started, turn the switch ① according to direction marked on switch to the normal position and turn the switch ② to FORWARD or REVERSE position.

The spindle will turn immediately by turning the switch ③. The speed can be adjusted by turning the switch ③. If the lathe needs to be stopped, turn the switch ③ to "0" position. If the direction of the lathe spindle needs to be changed, the switch ③ must be turned to "0" position at first. If the lathe must be stopped under emergency situation, press the Emergency Switch ① immediately. If the lathe needs to be started again, do so again according to the above mentioned process.

(SEE Fig. 4)

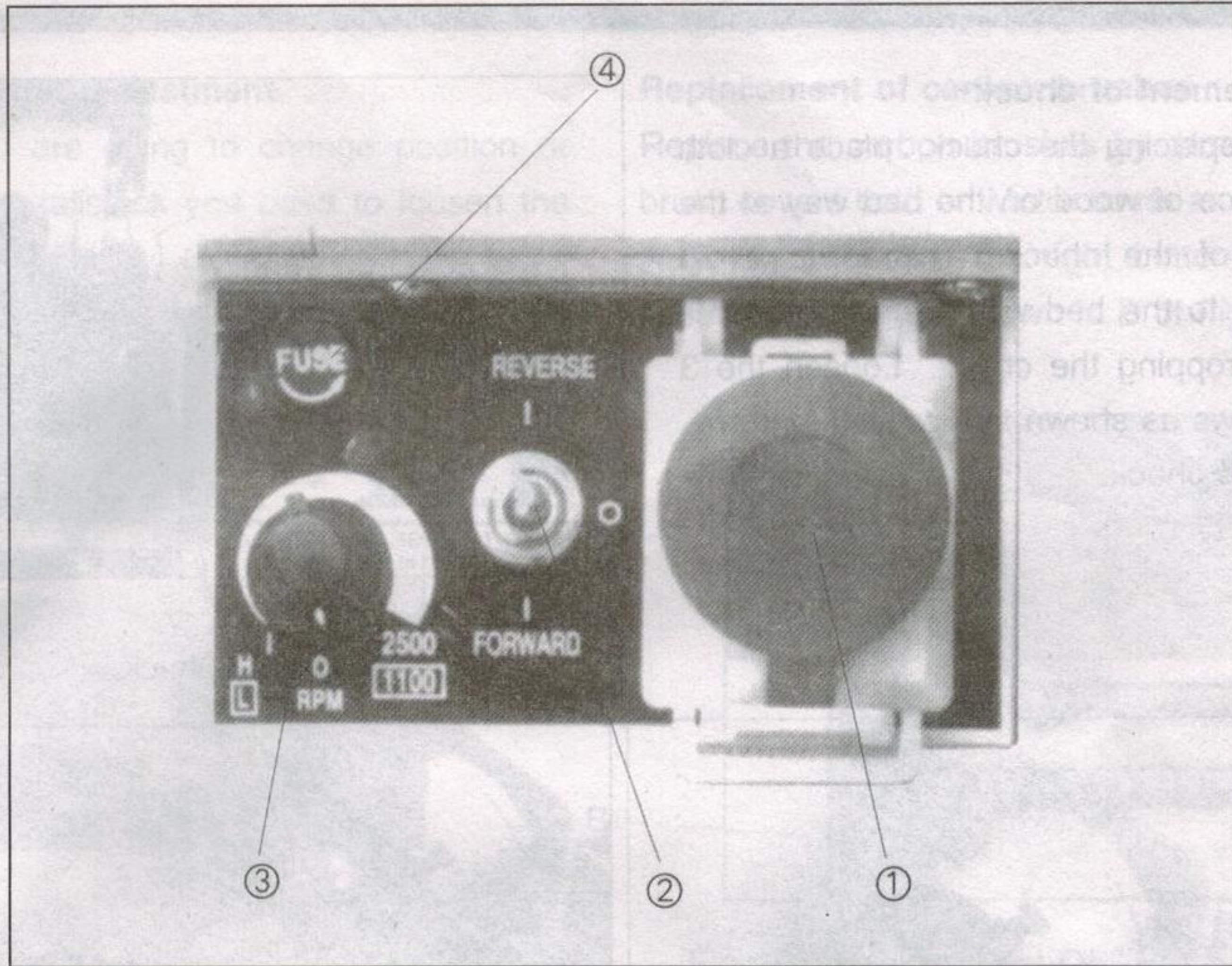

Fig. 4 Control Panel:

- 1. Emergency stop switch
- 2. Forward – reverse switch
- 3. Speed control knob
- 4. Fuse

- 6. Check the compound rest crank and the cross feeding crank and see if they work properly. If they are too tight or too loose, turn the adjusting screws located at both sides. (Fig. 5)

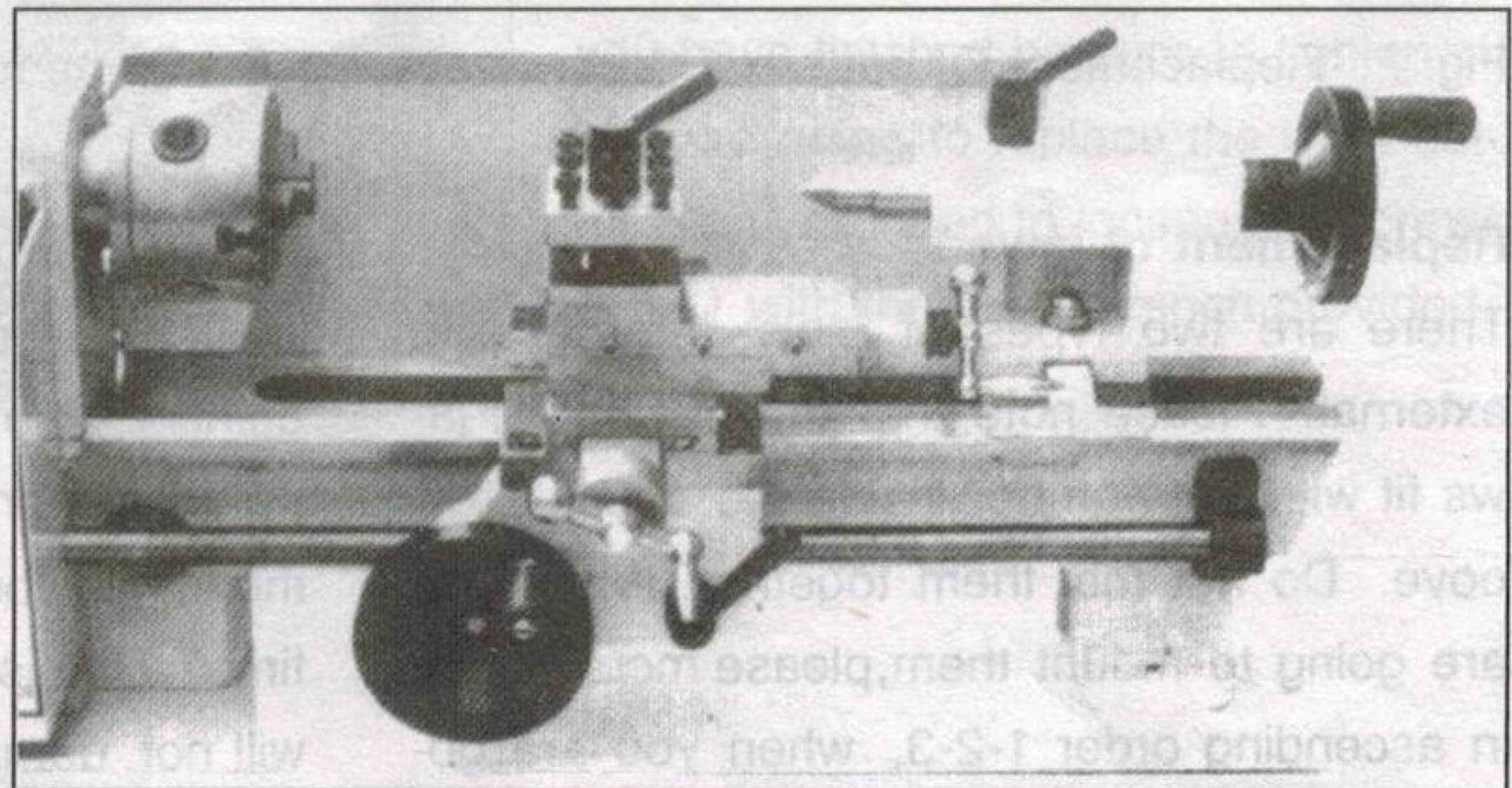

Fig. 5 Ajustment Of Saddle , Cross Slide And Compound Rest

Operation & Replacement

Replacement of chuck

When replacing the chuck, place a cloth or a piece of wood on the bed way at the bottom of the chuck. This is to avoid damage to the bed way caused by carelessly dropping the chuck. Loosen the 3 set screws as shown in Fig. 6. (A) to replace the chuck.

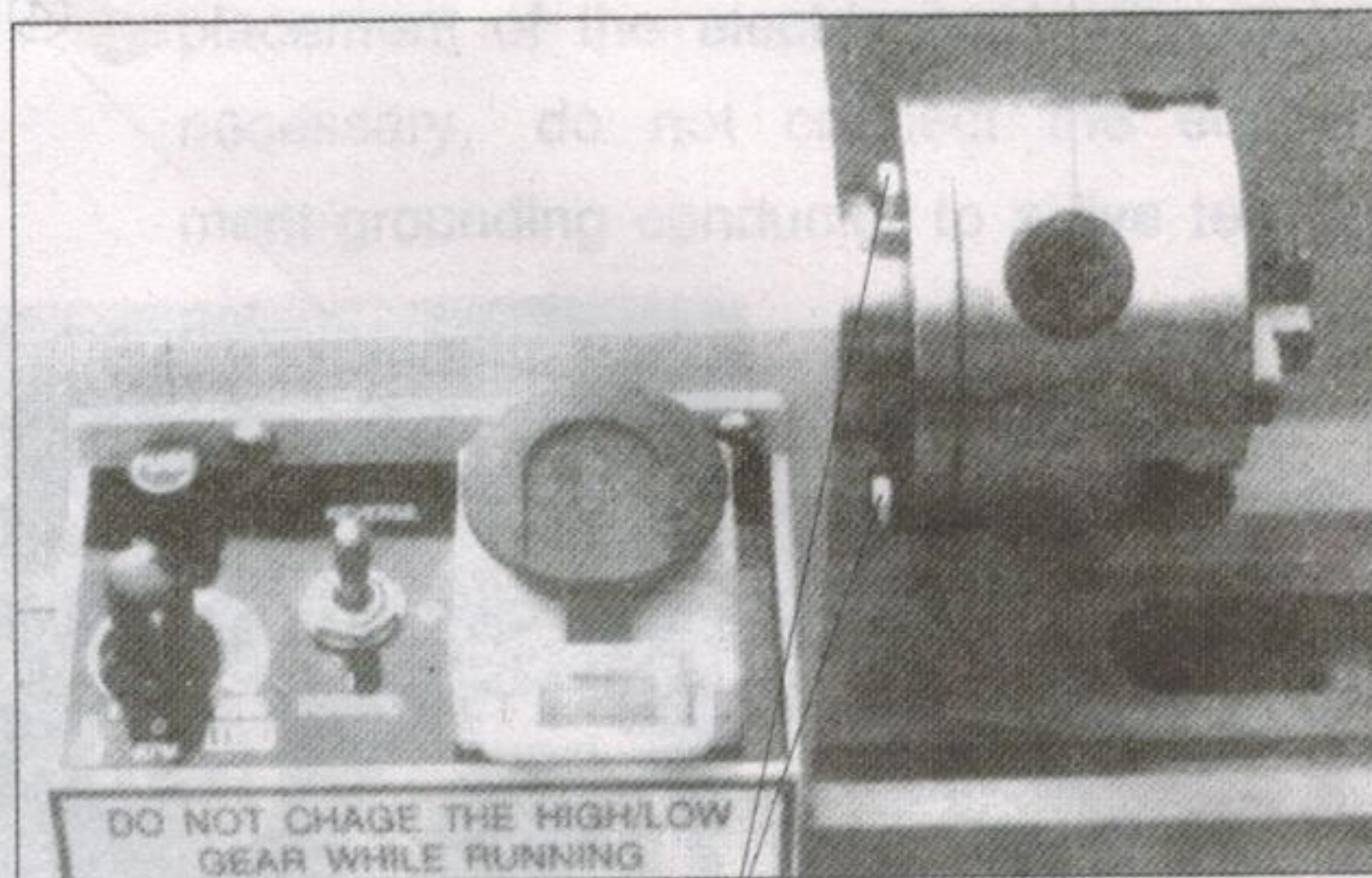

Fig. 6 Replacement Of Chuck

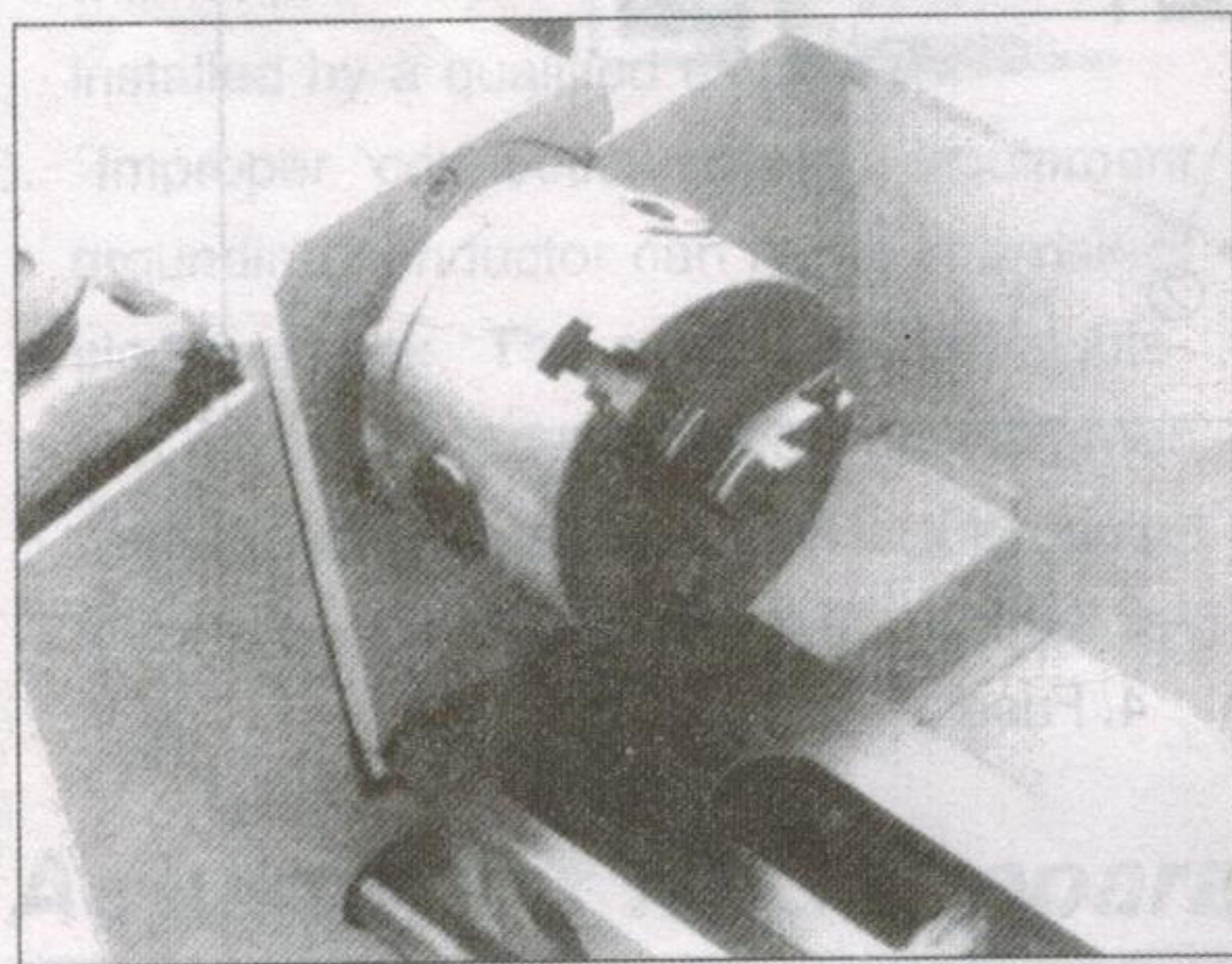

Fig. 7 Replacement Of Jaws

Replacement of jaws

There are two types of jaws: Internal and external. Please note that the number of jaws fit with the number inside the chuck's groove. Do not mix them together. When you are going to mount them, please mount them in ascending order 1-2-3, when you are going to take them out, be sure to take them out in descending order (3-2-1) one by one. After you finish this procedure, rotate the jaws to the smallest diameter and check that the three jaws are well fitted. If not you need

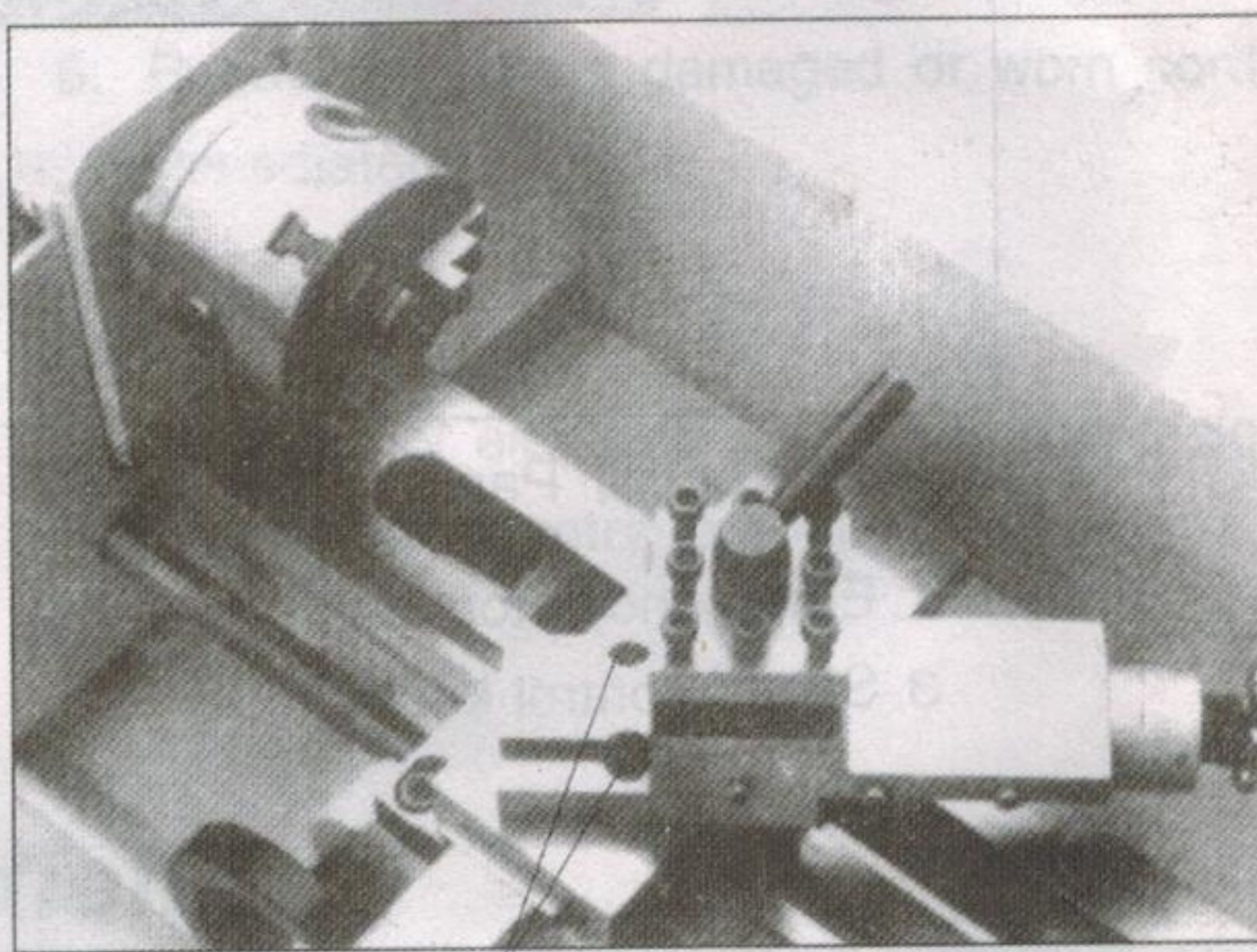

Fig. 8 Compound Rest Adjustment

to reassemble them again as they are not properly assembled (Fig. 7). When you are going to mount the work piece you need only to loosen one jaw. However, we recommend you loosen the three jaws at the same time, In this way you can protect them and will not damage the thread inside.

Compound rest adjustment

Loosen the two screws as shown in (A) of Fig. 8. After you have obtained the angle you desire, please do not forget to tighten them.

Tailstock rest adjustment

When you are going to change position or replace the tailstock you need to loosen the nut as shown in (A) of Fig. 9.

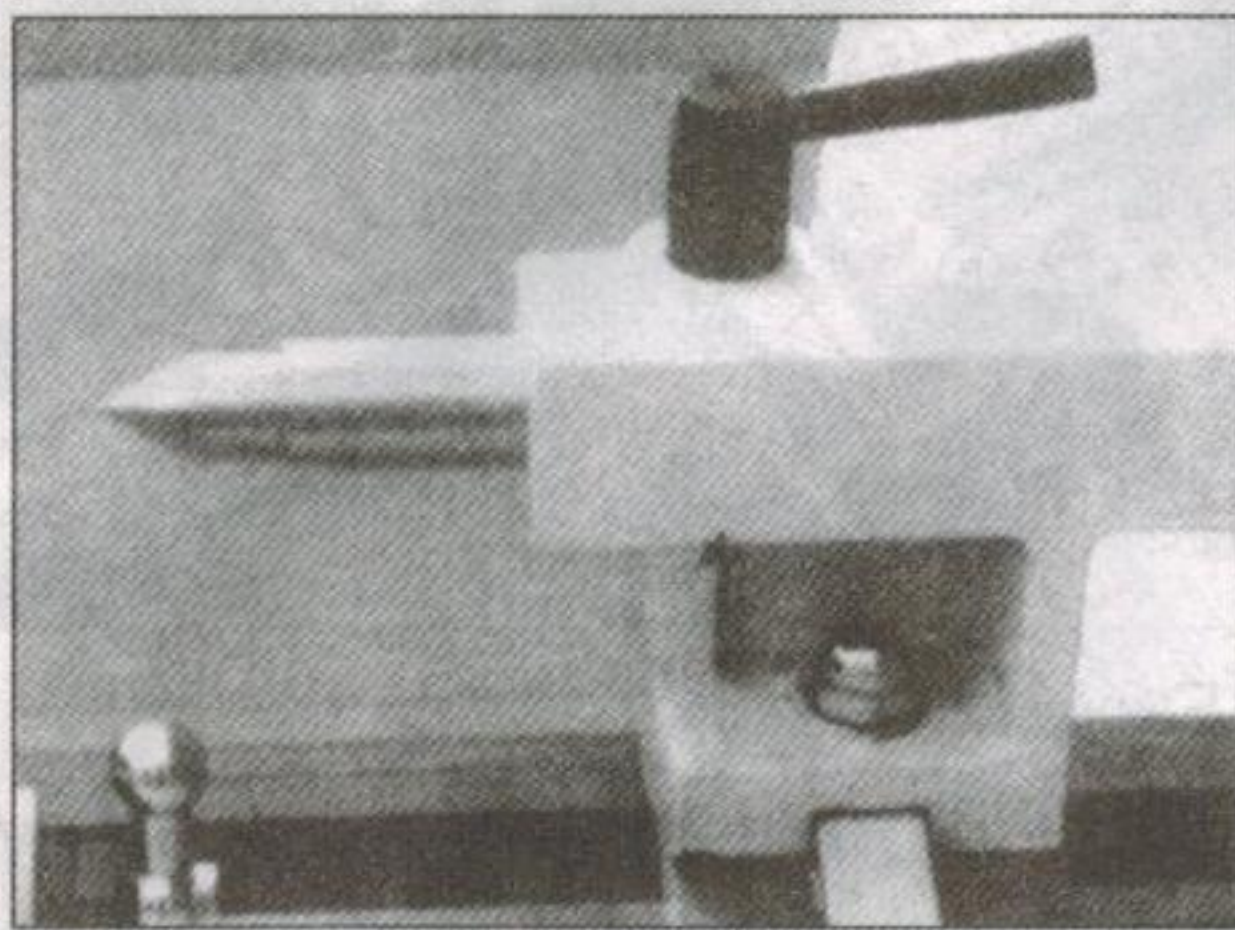

Fig. 9 Tailstock Rest Adjustment

Replacement of carbon brushes

Replace the carbon brushes by removing the brush covers both on Motor cover as shown in A of Fig. 10-A and the right bottom side of speed controller as shown in B of Fig. 10-B.

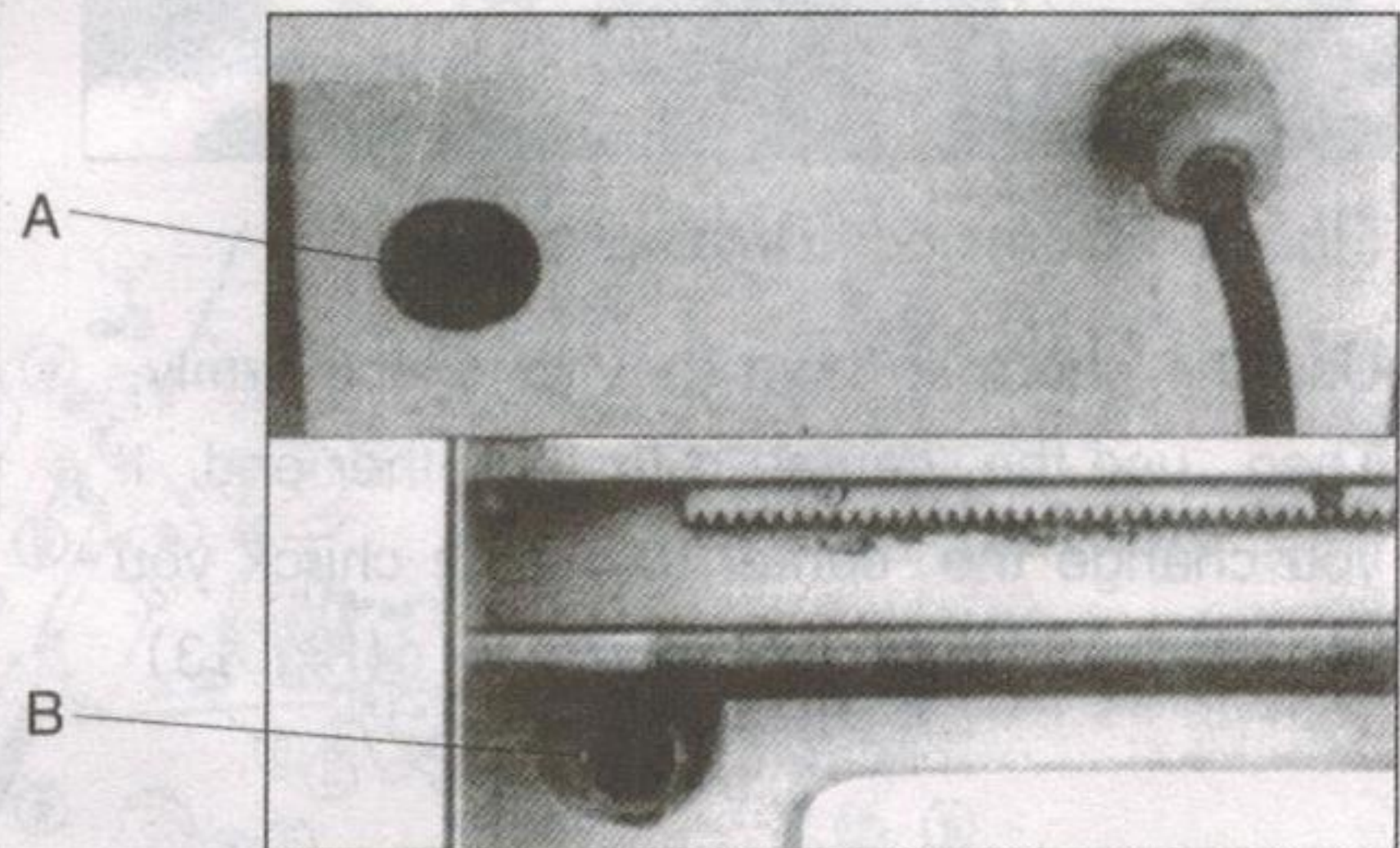

Fig. 10 Replacement Of Carbon Brushes

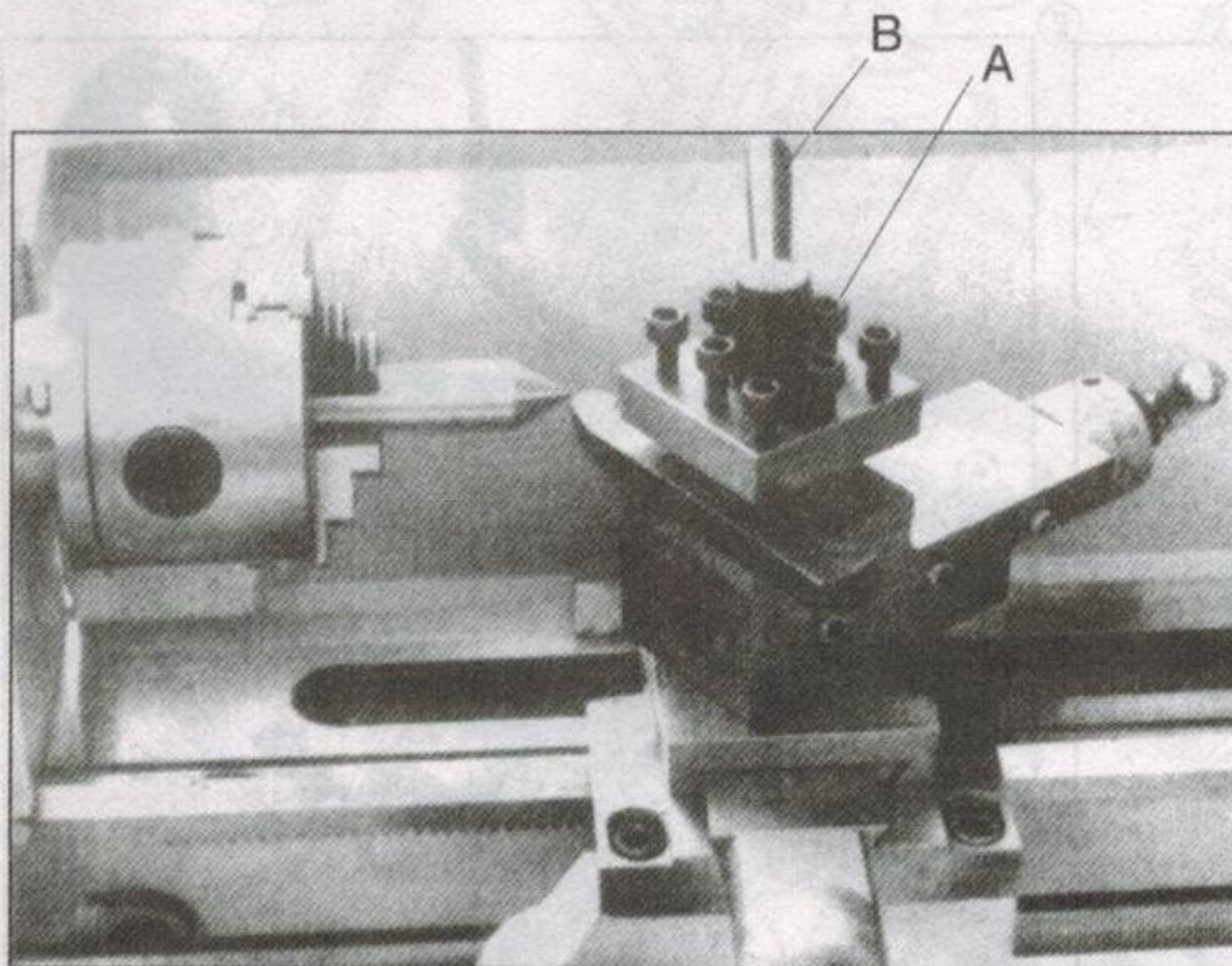

Fig. 11 Tool Post Adjustment

Tool post adjustment

When you are going to adjust the tool post position, you only need to loosen the lever shown in (B) of Fig. 11. After you have finished be sure to tighten. If you are going to replace the work cutter then you need to loosen the screws of (A) with the allen wrench provided.

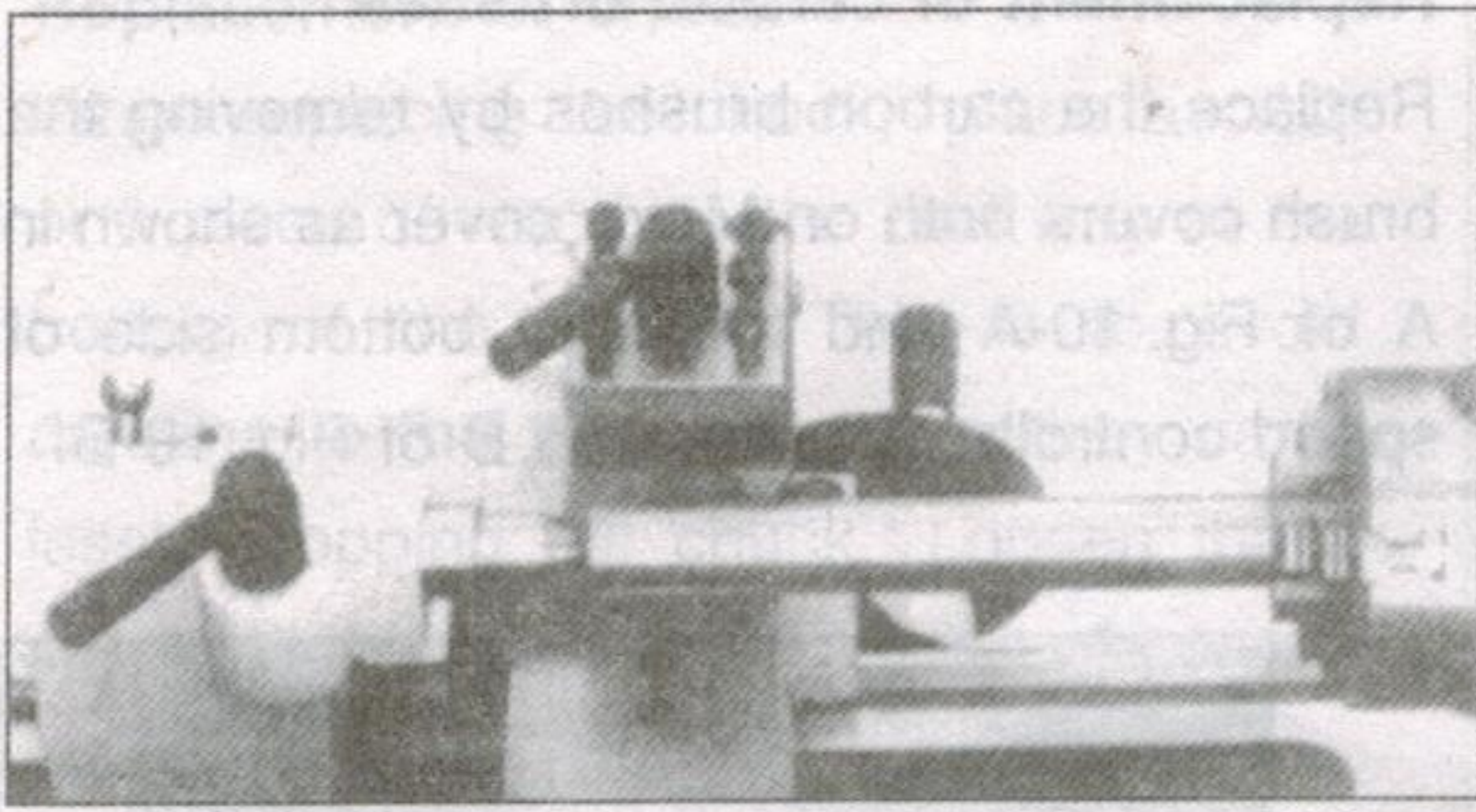

Fig. 13 Workpiece Holding And Drilling

Use the chuck to hold the workpiece firmly. Then, use the center to fix the other end. If you change the center to drilling chuck you can start your drilling immediately. (Fig. 13)

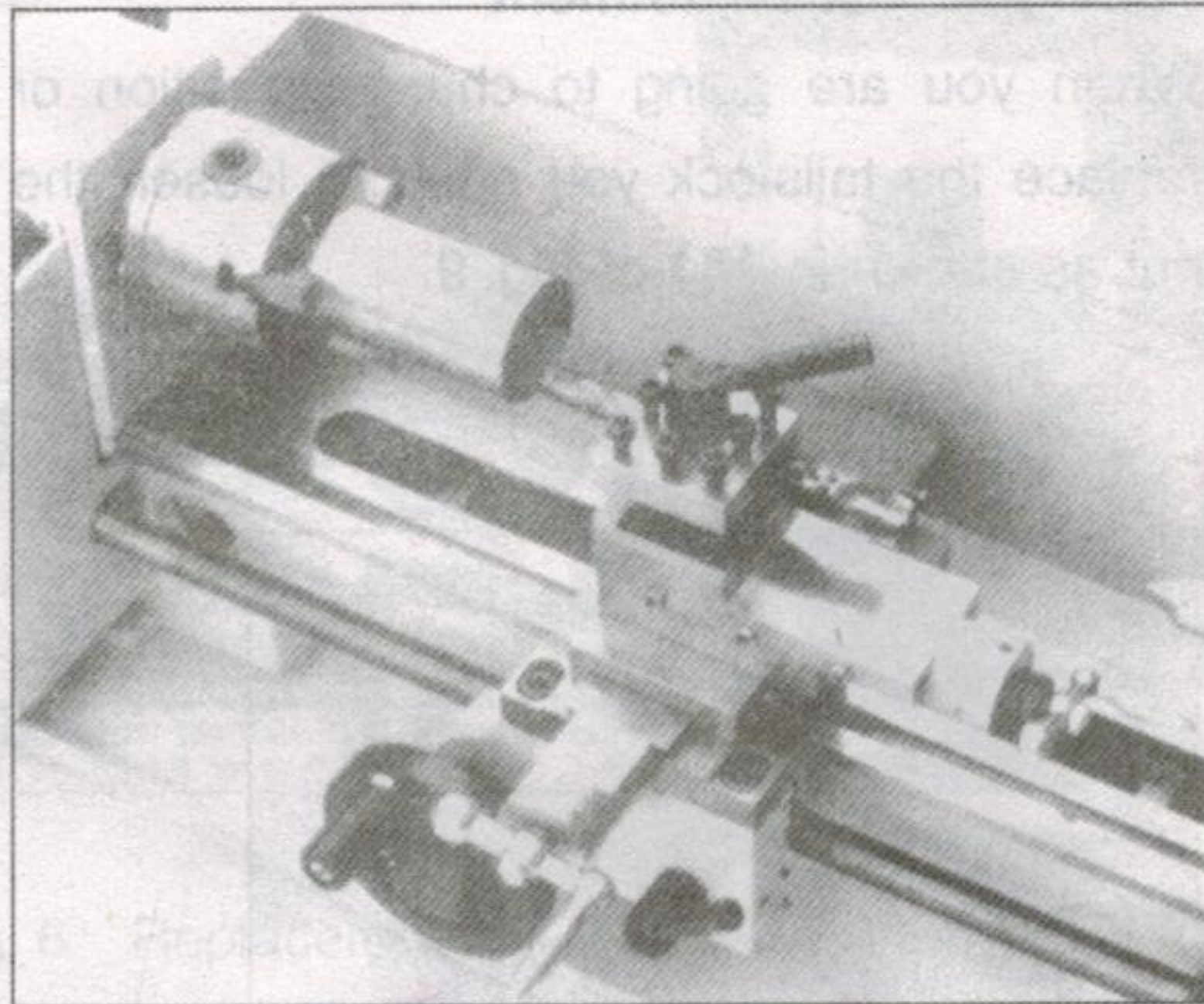

Fig. 14 Face Cutting

Use the chuck to hold the workpiece firmly and the cutter to start lathe's face cutting as shown in Fig. 14 (edge of the cutter must be at the same height as the center)

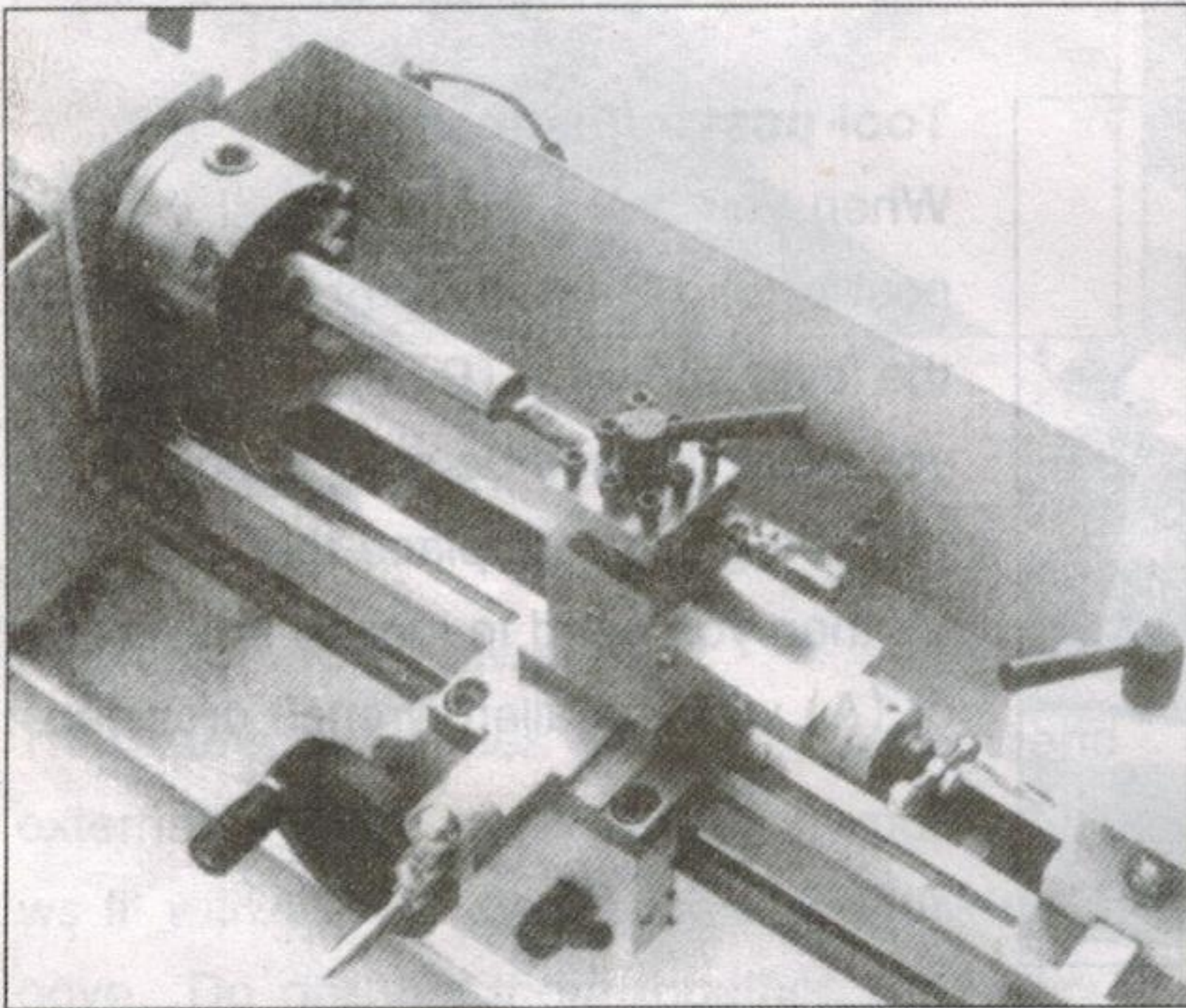

Fig. 15 Internal Cutting

By changing the tool post angle and adjusting the compound rest, you can do internal cutting as in Fig. 15.

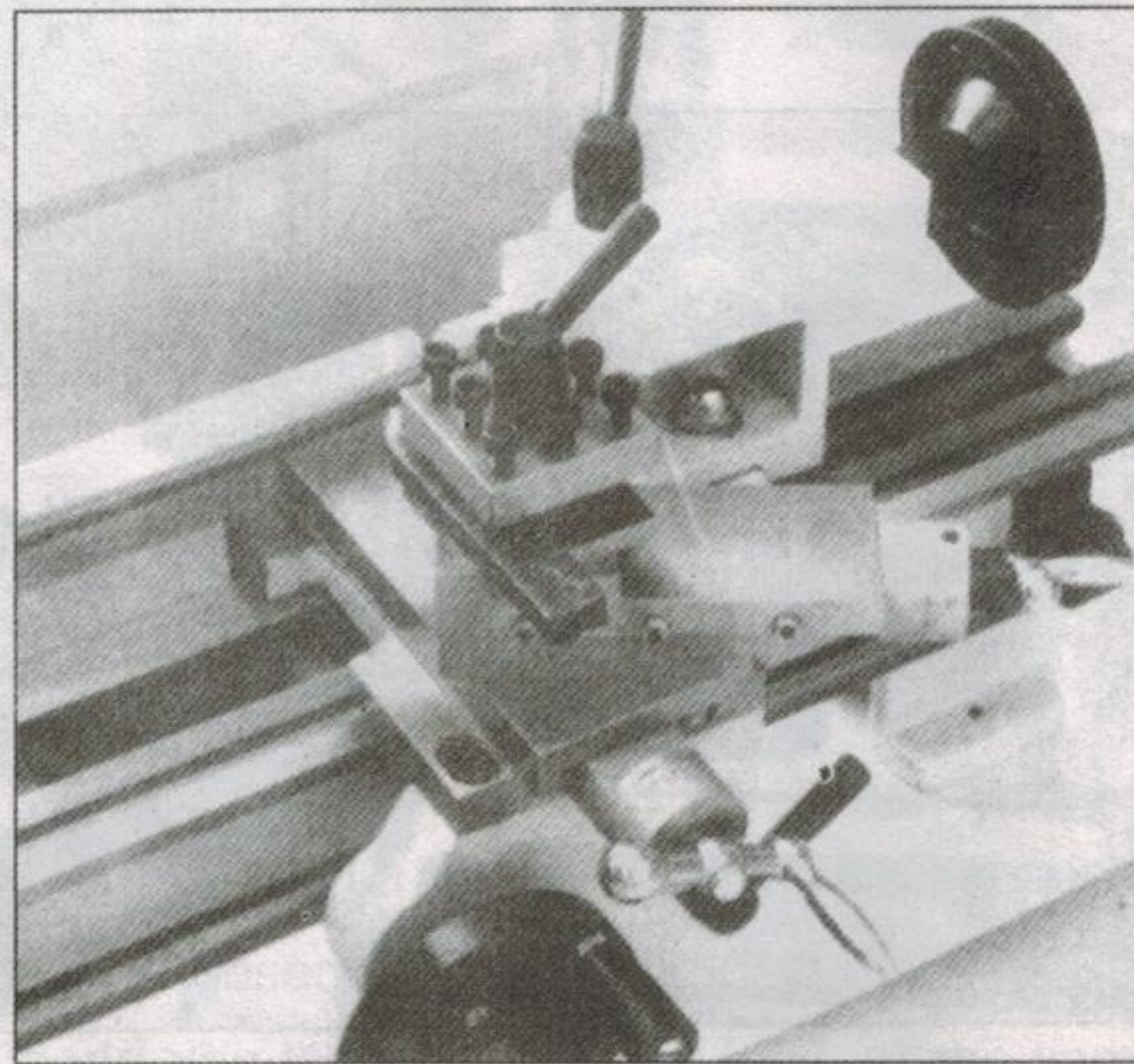
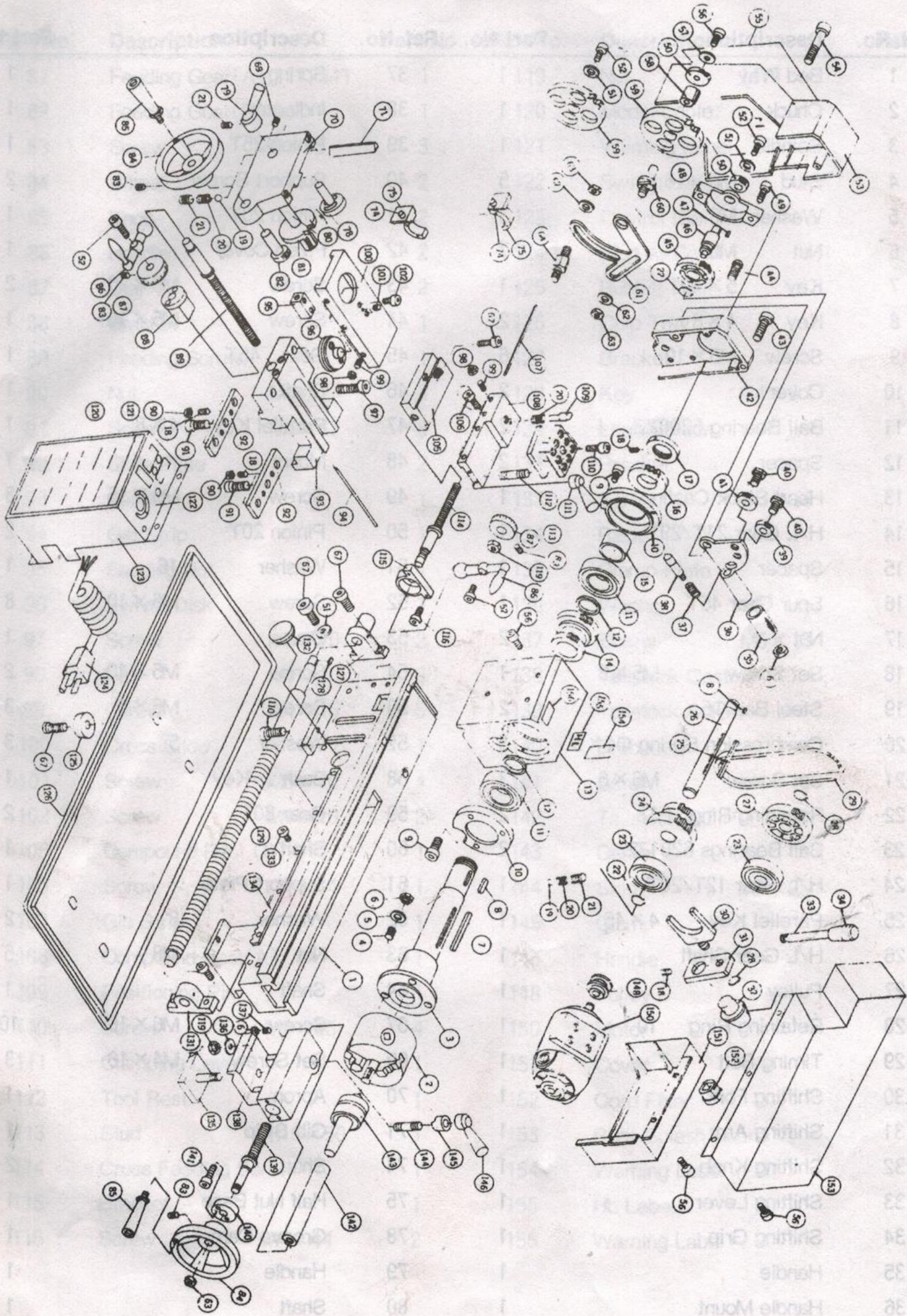

Fig. 16 Bevel Cutting

After adjusting the angle of the compound rest, you can do bevel cutting as in Fig. 16.

Assembly Diagram and Parts List



Ref. No.	Description	Part No.	Ref. No.	Description	Part No.
1	Bed Way	1	37	Spring	1
2	Chuck	1	38	Indicator	1
3	Spindle	1	39	Pinion 25T	1
4	Stud M6 × 16	5	40	Support Screw	2
5	Washer M6	3	41	Pinion 20T	1
6	Nut M6	7	42	Fixed Cover	1
7	Key 5 × 40	1	43	Screw M6 × 20	2
8	Key 4 × 8	2	44	Screw M5 × 10	1
9	Screw M5 × 10	6	45	Gear 45T	1
10	Cover	2	46	Shaft	1
11	Ball Bearing 6206ZZ	2	47	Parallel Key 4 × 8	1
12	Spacer	2	48	Mount	1
13	Head Stock Casting	1	49	Screw M5 × 15	3
14	H/L Gear 21T/29T	1	50	Pinion 20T	2
15	Spacer	1	51	Washer 16	1
16	Spur Gear 45T	1	52	Screw M5 × 10	8
17	Nut	2	53	Cover	1
18	Set Screw M5 × 8	1	54	Screw M5 × 40	2
19	Steel Ball Φ5	2	56	Screw M6 × 6	3
20	Compression Spring Φ4 × 9	3	57	Washer 5	3
21	Set Screw M6 × 6	3	58	Bush w/Key	1
22	Retaining Ring 12	2	59	Gear 80T	2
23	Ball Bearings 6201ZZ	2	60	Shaft	1
24	H/L Gear 12T/20T	1	61	Support Plate	1
25	Parallel Key 4 × 45	1	62	Washer 8	2
26	H/L Gear Shaft	1	63	Nut M8	5
27	Pulley	1	64	Shaft	1
28	Retaining Ring 10	1	67	Screw M6 × 16	10
29	Timing Belt	1	69	Set Screw M4 × 10	3
30	Shifting Fork	1	70	Apron	1
31	Shifting Arm	1	71	Gib Strip	1
32	Shifting Knob	1	74	Shaft	2
33	Shifting Lever	1	75	Half Nut Base	1
34	Shifting Grip	1	78	Groove Cam	1
35	Handle	1	79	Handle	1
36	Handle Mount	1	80	Shaft	1

No.

Ref. No.	Description	Part No.	Ref. No.	Description	Part No.
81	Feeding Gear(A) 11T/54T	1	119	Nut M10	2
82	Feeding Gear(B) 24T	1	120	Model Lable	1
83	Screw M6 × 12	3	121	Warning Label	1
84	Wheel	2	122	Switch Label	1
85	Knob	2	123	Control Box	1
86	Handle	2	124	Plug w/Cord	1
87	Dial	2	125	Rubber Pad	4
88	Bracket	1	126	Chip Tray	1
89	Feeding Screw	1	127	Bracket	1
90	Nut M5	3	128	Key B4 × 8	1
91	Screw M6 × 12	6	129	Lead Screw	1
92	Slide Plate	2	131	Bracket	1
93	Saddle	1	133	Screw M3 × 10	4
94	Gib Strip	1	134	Rack	1
95	Feeding Nut	1	135	Clamp Plate	1
96	Swivel Disk	1	136	Washer 10	2
97	Screw M8 × 20	2	137	Screw M5 × 15	1
98	Nut M4	6	138	Tailstock Casting	1
99	Screw M4 × 16	6	139	Tailstock Screw	1
100	Cross Slide	1	140	Bracket	1
101	Screw M5 × 10	4	141	Screw M4 × 10	6
102	Screw M4 × 10	2	142	Tailstock Quill	1
105	Compound Rest (B)	1	143	Center	1
106	Screw M4 × 14	1	144	Stud M8 × 25	1
107	Gib Strip	1	145	Clamp	1
108	Compound Rest(A)	1	146	Handle	1
109	Positioning Pin	1	148	Pulley	1
110	Screw M8 × 25	4	150	Motor	1
111	Clamping Lever	1	151	Cover	1
112	Tool Rest	1	152	Cord Fixer	1
113	Stud M10 × 50	1	153	Rear Splash Guard	1
114	Cross Feeding Screw	1	154	Warning Label	1
115	Bracket	1	155	HL Label	1
116	Screw M4 × 14	2	156	Warning Label	1



New SAFETY RULES for Stationary Power Tools

follow them for best results and full benefit from shop machines

Every good craftsman respects the tools with which he works. He knows they represent years of constantly improved design. He also knows that they are dangerous if misused.

This is the theme of a new safe-use program developed by the Power Tool Institute, Inc., for stationary power tools. The institute has put together a list of safety rules, based on approved practices in industrial and home shops, to accompany a set of new standards for stationary power tools that members of the institute manufacture.

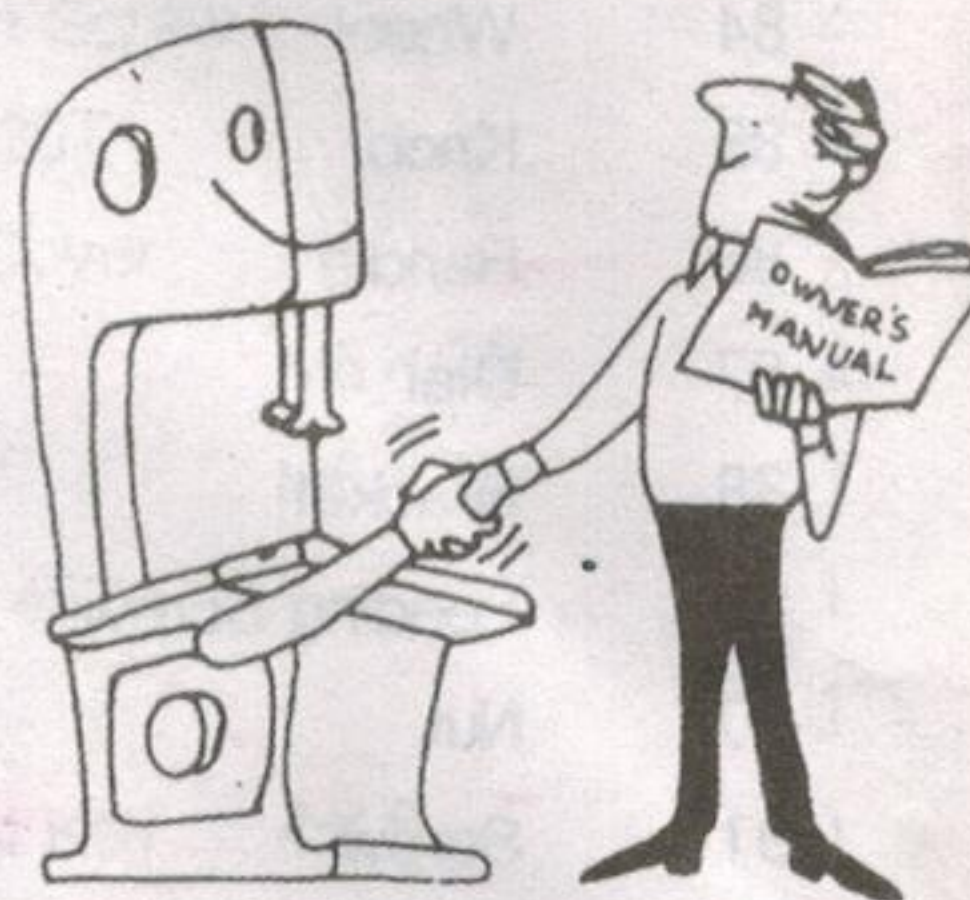

1 Know your power tool. Read the owner's manual carefully. Learn its applications and limitations, as well as the specific potential hazards peculiar to this tool.

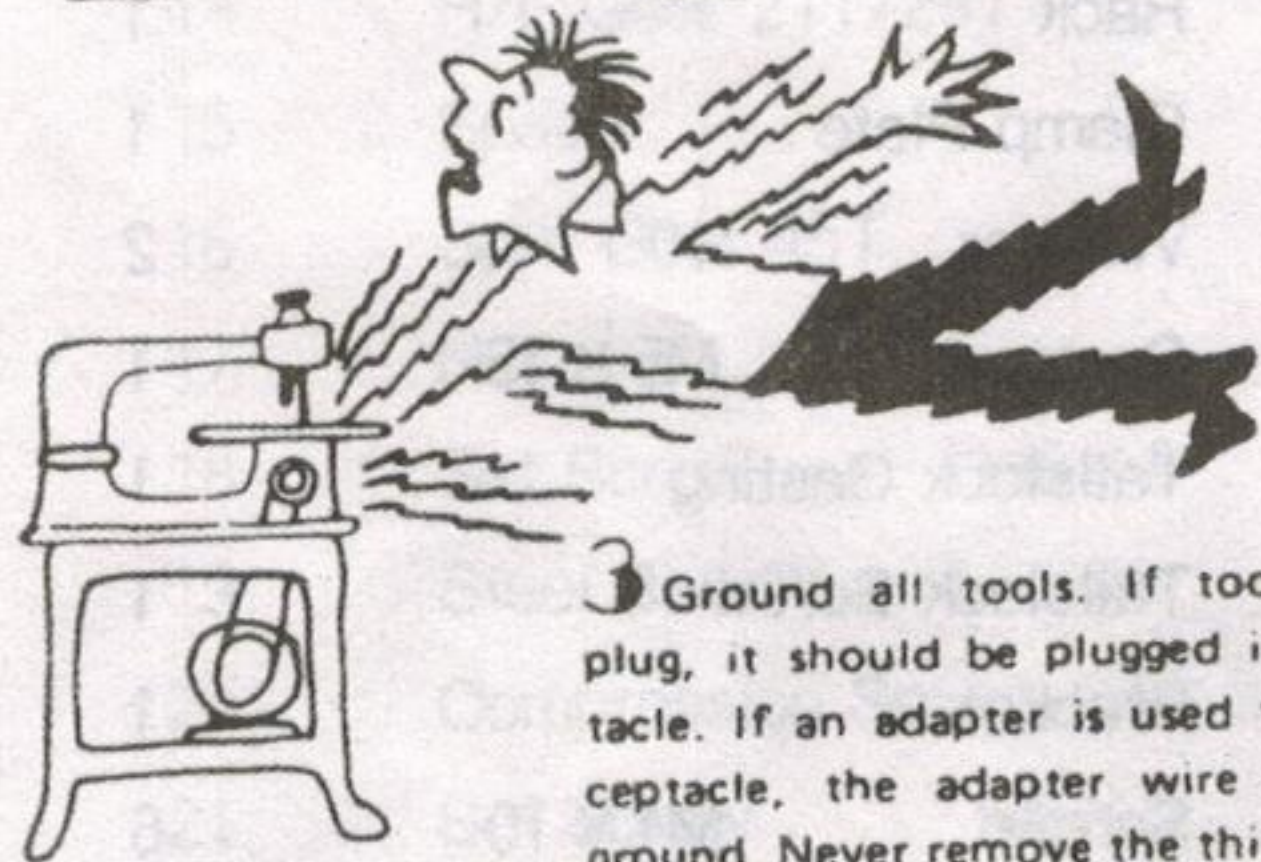

3 Ground all tools. If tool is equipped with three-prong plug, it should be plugged into a three-hole electrical receptacle. If an adapter is used to accommodate a two-prong receptacle, the adapter wire must be attached to a known ground. Never remove the third prong.

2 Keep guards in place and in working order.

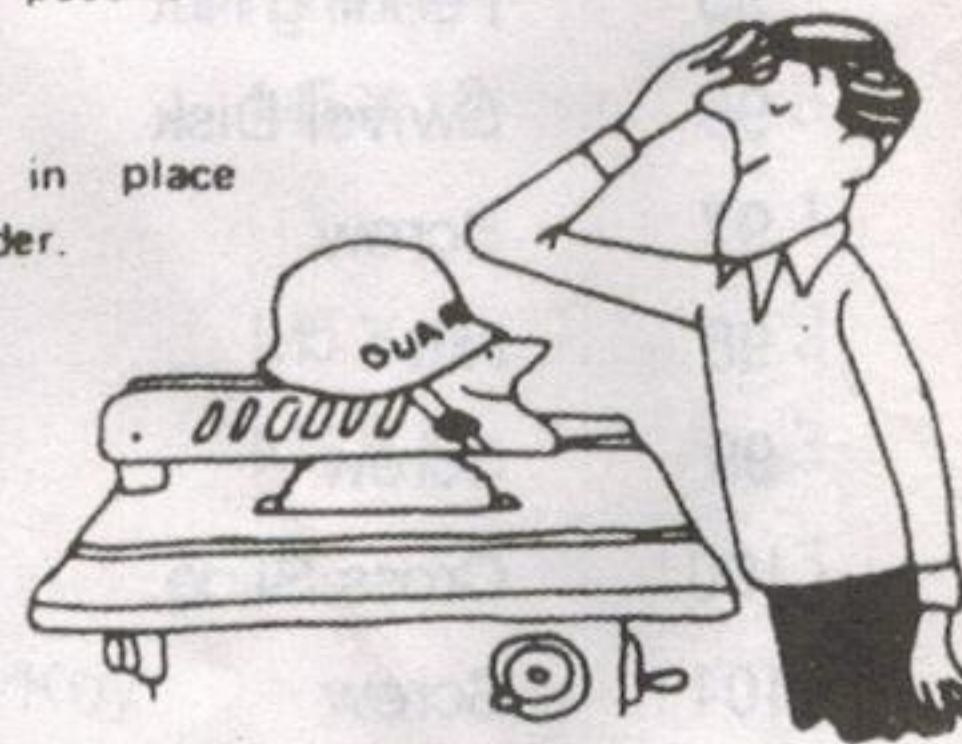

4 Remove adjusting keys and wrenches. Form habit of checking to see that keys and adjusting wrenches are removed from tool before turning it on.

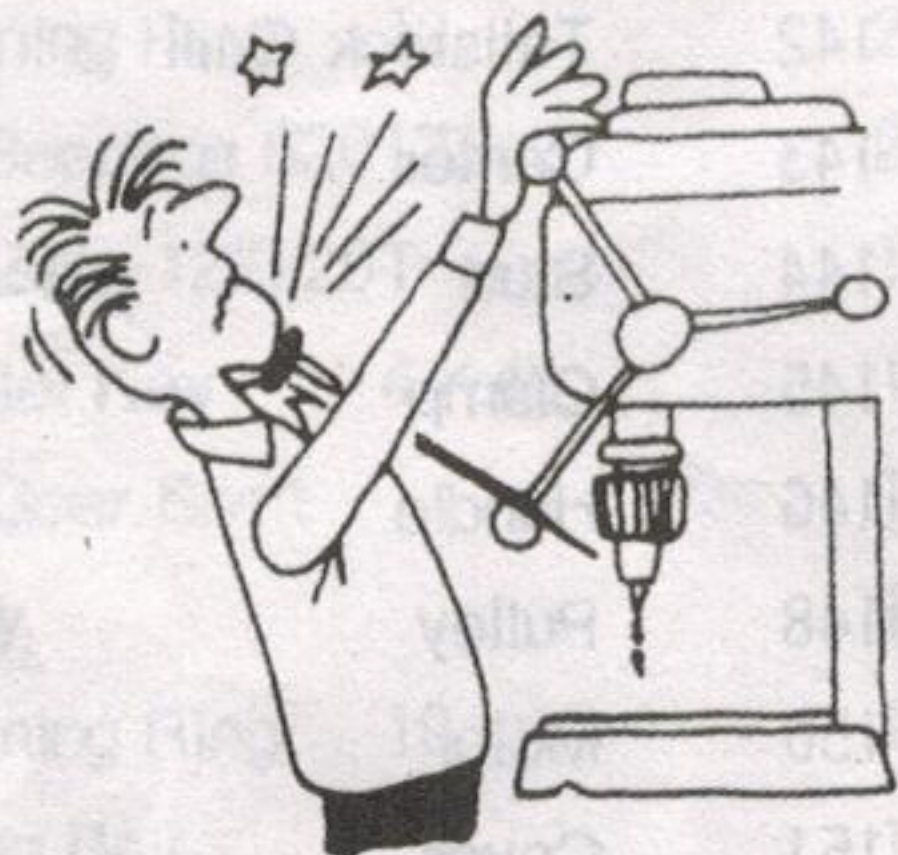

5 Keep work area clean. Cluttered areas and benches invite accidents.



6 Avoid dangerous environment. Don't use power tools in damp or wet locations or expose them to rain. Keep your work area well lighted.

7 Keep children away. All visitors should be kept a safe distance from work area.



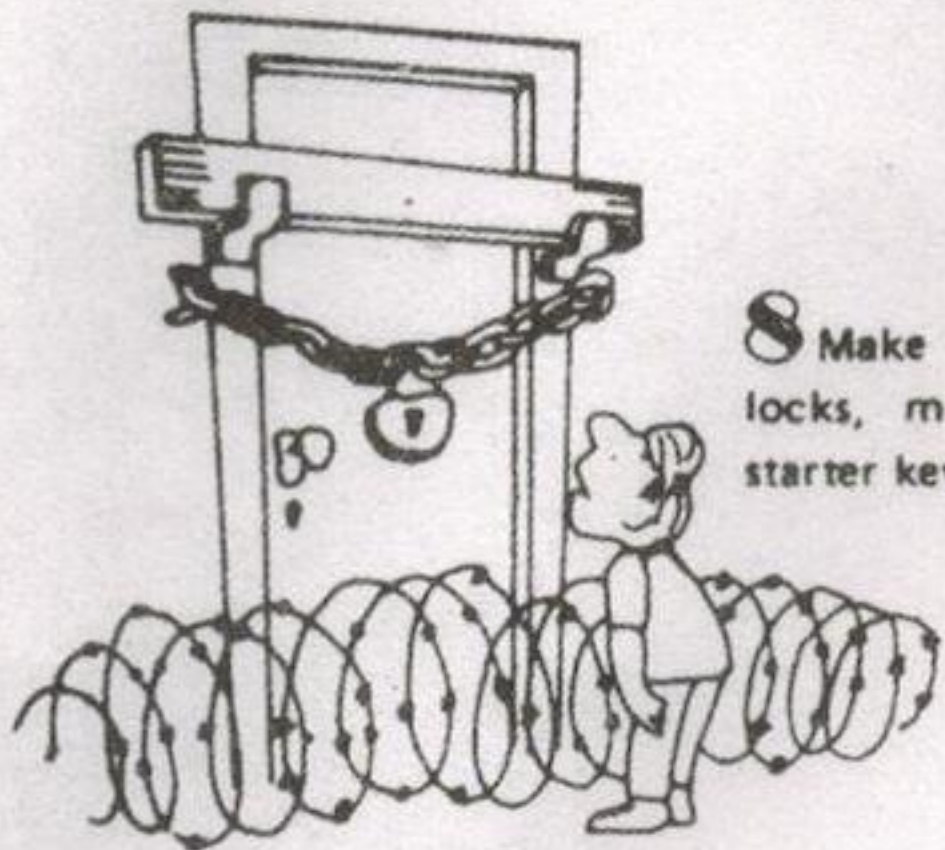

8 Make workshop kidproof — with padlocks, master switches, or by removing starter keys.

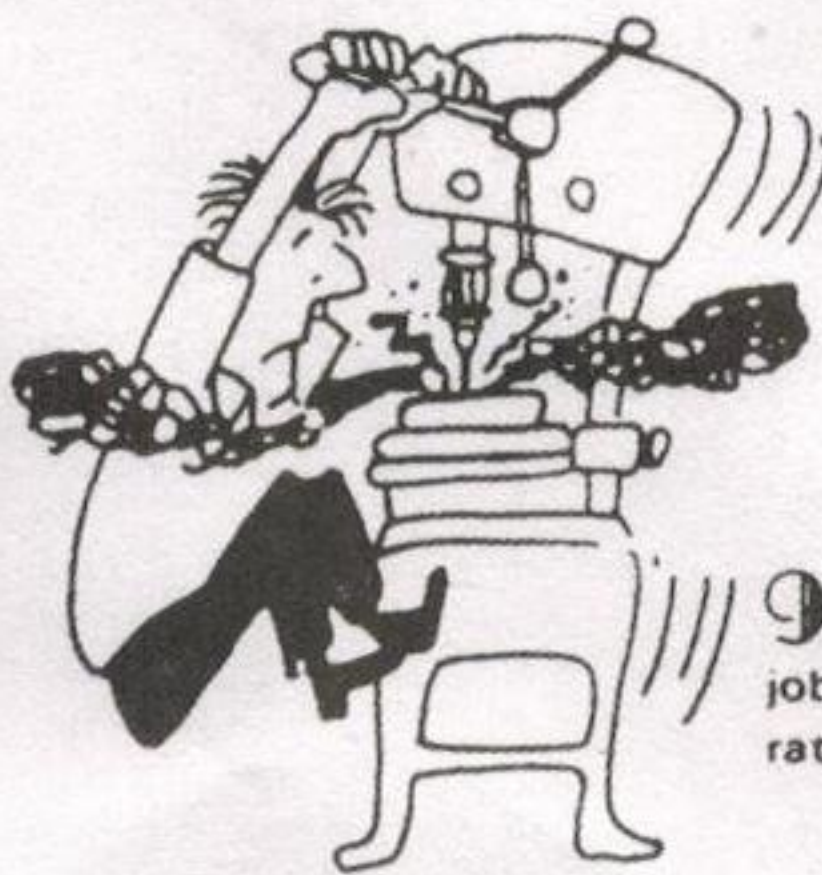

9 Don't force tool. It will do the job better and be safer at the rate for which it was designed.

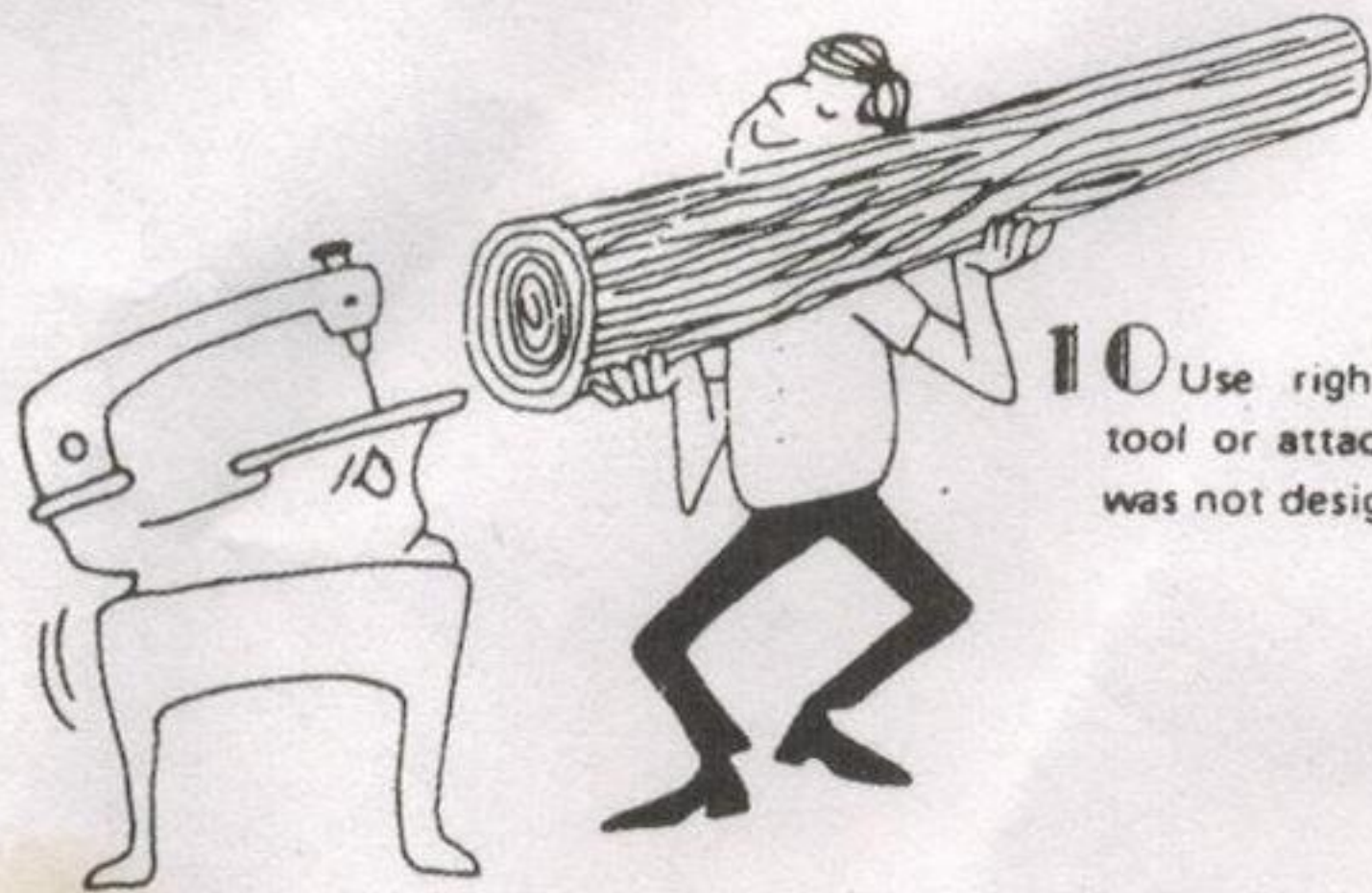

10 Use right tool. Don't force tool or attachment to do a job it was not designed for.

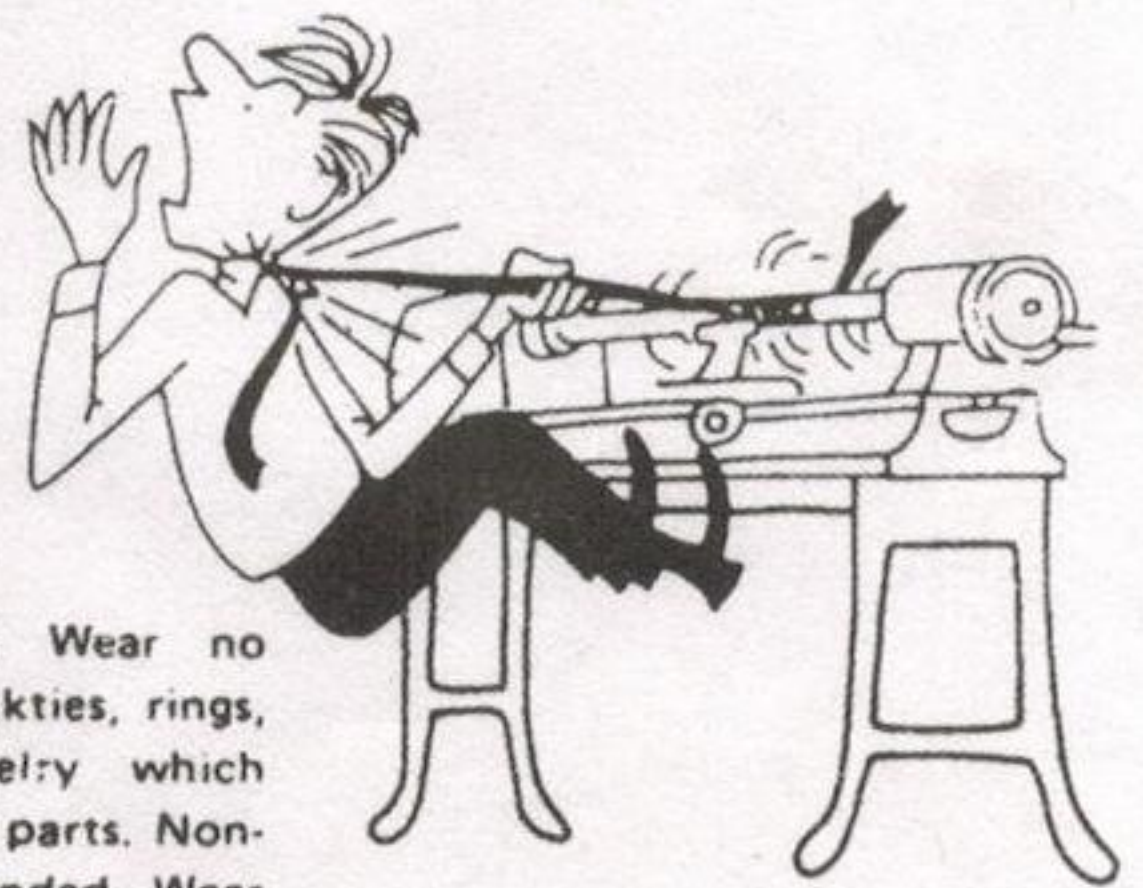

11 Wear proper apparel. Wear no loose clothing, gloves, neckties, rings, bracelets, or other jewelry which may get caught in moving parts. Non-slip footwear is recommended. Wear protective hair covering to contain long hair.



12 Always use safety glasses. Also use face or dust mask if cutting operation is dusty. Everyday eyeglasses only have impact resistant lenses. They are NOT safety glasses.



13 Secure work. Use clamps or vise to hold work, when practical. It's safer than using your hands and it frees both hands to operate tool.

14 Don't overreach. Keep proper footing and balance at all times.



15 Maintain tools with care. Keep tools sharp and clean for best and safest performance. Follow instructions for lubricating and changing accessories.



16 Disconnect tools before servicing and when changing accessories such as blades, bits, cutters and the like.

17 Use recommended accessories. Consult owner's manual for recommended accessories. Use of improper accessories may cause risk of injury to persons.



18 Reduce the risk of unintentional starting. Make sure switch is in off position before plugging in.