

7" X 12" HORIZONTAL BAND SAW INSTRUCTION MANUAL

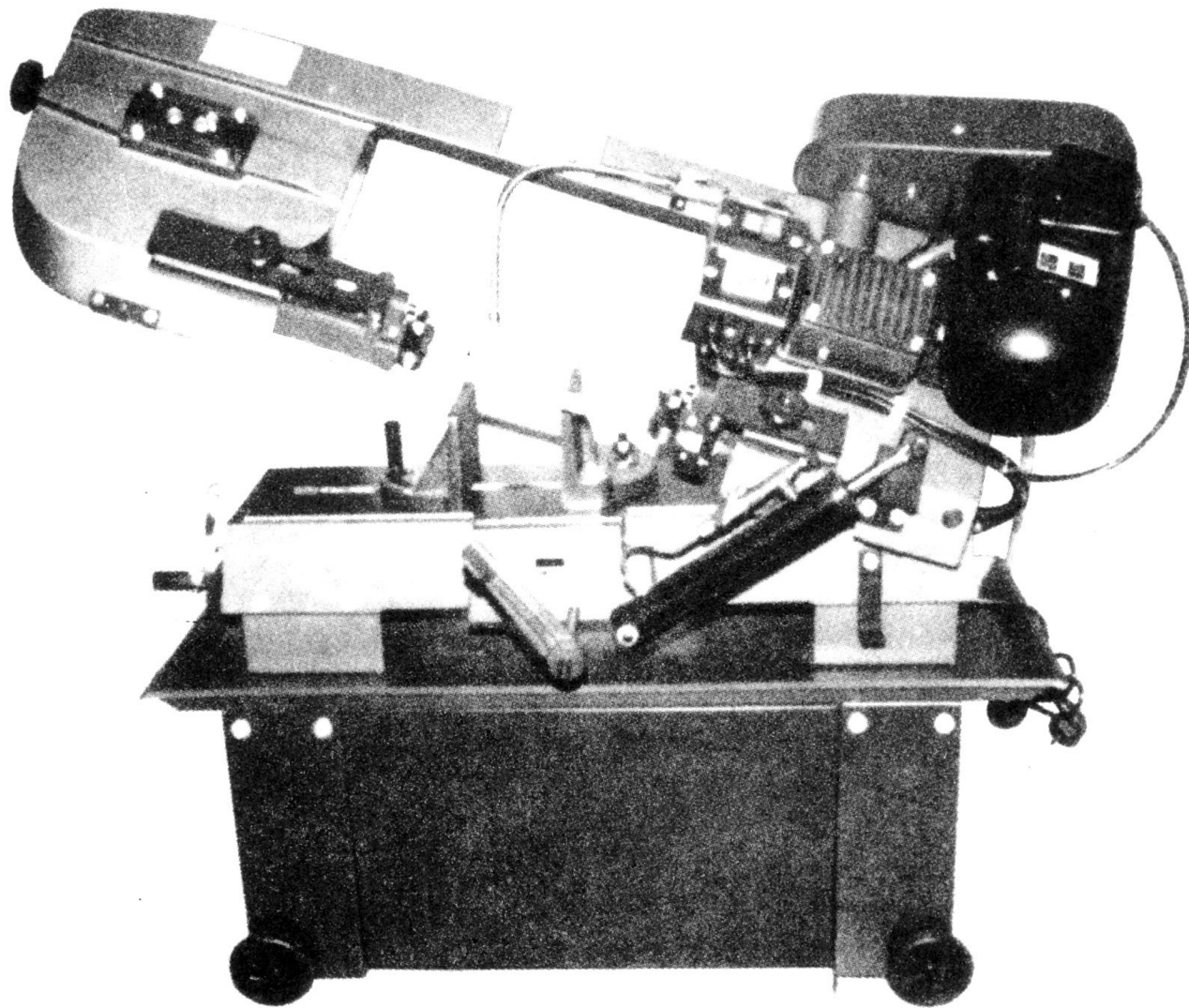

FOR YOUR SAFETY:

Please read this manual carefully before operating the machine and retain it for future reference.

SAFETY RULES

“Warning! When using electric tools basic safety precaution should always be followed to reduce the risk of fire, electric shock and personal injury, including the following.

Read all these instructions before attempting to operate this product and save these instructions.”

- 1- **Keep work area clear**
 - Cluttered areas and benches invite injuries.
- 2- **Consider work area environment**
 - Do not expose tools to rain.
 - Do not use tools in damp or wet locations.
 - Keep work area well lit.
 - Do not use tools in the presence of flammable liquids or gases.
- 3- **Guard against electric shock**
 - Avoid body contact with earthed or grounded surfaces.
 - Make certain the machine is properly grounded.
- 4- **Keep other persons away**
 - Do not let persons, especially children, not involved in the work touch the tool or the extension cord and keep them away from the work area.
- 5- **Store idle tools**
 - When not in use, tools should be stored in a dry locked-up place, out of reach of children.
- 6- **Do not force the tool**
 - It will do the job better and safer at the rate for which it was intended.
- 7- **Use the right tool**
 - Do not force small tools to do the job of a heavy-duty tool.
 - Do not use tools for purposes not intended; for example do not use circular saws to cut tree limbs or logs.
- 8- **Dress properly**
 - Do not wear loose clothing or jewelry; they can be caught in moving parts.
 - Non-skid footwear is recommended when working outdoors.
 - Wear protective hair covering to contain long hair.
- 9- **Use protective equipment**
 - Use approved safety glasses/face shields while using this machine.
 - Use face or dust mask if cutting operations create dust.
- 10- **Connect dust extraction equipment**
 - If device are provided for the connection of dust extraction and collecting equipment, ensure these are connected and properly used.
- 11- **Do not abuse the cord**
 - Never yank the cord to disconnect it from the socket.
- 12- **Secure work**
 - Where possible use clamps or a vice to hold the work. It is safer than using your hand.
- 13- **Do not overreach**
 - Keep proper footing and balance at all times.
- 14- **Maintain tools with care**
 - Keep cutting tools sharp and clean for better and safer performance.
 - Follow instructions for lubricating and changing accessories.
 - Inspect tool cords periodically and if damaged have them repaired by an authorized service facility.
 - Inspect extension cords periodically and replace if damaged.
 - Keep handles dry, clean and free from oil and grease.
- 15- **Disconnect tools**
 - When not in use, before servicing and when changing accessories such as blades, bits and cutters, disconnect tools from the power supply.
- 16- **Remove adjusting keys and wrenches**
 - Form the habit of checking to see that keys and adjusting wrenches are removed from the tool before turning it on.
- 17- **Avoid unintentional starting**
 - Ensure switch is in “off” position when plugging in.
- 18- **Use outdoor extension leads**
 - When the tool is used outdoors, use only extension cords intended for outdoor use and so marked.
- 19- **Stay alert**
 - Watch what you are doing, use common sense and do not operate the tool when you are tired.
- 20- **Check damaged parts**
 - Before further use of tool. It should be carefully checked to determine that it will operate properly and perform its intended function.
 - Check for alignment of moving parts, binding of moving parts, breakage of parts, mounting and any other conditions that may affect its operation.
 - A guard or other part that is damaged should be properly repaired or replaced by an authorized service center unless otherwise indicated in this instruction manual.
 - Have defective switches replaced by an authorized

service center.

-Do not use the tool if the switch does not turn it on and off.

21- Warning

-The use of any accessory or attachment other than one recommended in this instruction manual may present a risk of personal injury.

22- Have your tool repaired by a qualified person

-This electric tool complies with the relevant safety rules. Repairs should only be carried out by qualified persons using original spare parts, otherwise this may result in considerable danger to the user.

23- Never stand on tool. Serious injury could occur if the tool is tipped or if the cutting tool is accidentally contacted.

24- As to the power supply, the error of the voltage should be within +/-10%V, the rate error should be within +/-1Hz.

25- Operating condition:

 **WARNING**

1. Keep machine guards in place at all times when the machine is in use. If removed for maintenance purposes, use extreme caution and replace the guards immediately.
2. Do not over reach. Maintain a balanced stance at all times so that you do not fall or lean against blades or other moving parts.
3. Replace warning labels if they become obscured or removed.
4. Give your work undivided attention. Looking around, carrying on a conversation, and "horse-play" are careless acts that can result in serious injury. Never leave tool running unattended. Turn power off. Don't leave tool until it comes to a complete stop.
5. Always keep hands and fingers away from the blade when the machine is running.
6. Never hold the material with the saw in the horizontal position. Always use the vise and clamp it securely.
7. Read and understand warnings posted on the machine.
8. Keep the belt guard and wheel covers in place and in working order.
9. Always provide adequate support for long and heavy material.
10. In urgent circumstances, the oil jar should be closed immediately to keep away from accident.
11. Never clean the sawblade or band wheel of a band saw using a hand-held brush or scraper whilst the sawblade is in motion.
12. Adjust and position the blade guide arm before start-

- 1) The temperature of the environment should range from 5° to 40°.
 - 2) The relative humidity should be within 30%~95%.
 - 3) The altitude should not be higher than 1000M.
 - 4) In transiting and storing condition, the machine should be kept within the temperature between -25° and 55°.
- 26- The power supply must be installed with undervoltage protecting facility.
- 27- The power supply must be installed with overvoltage protecting facility.
- 28- Guarding gloves, glasses and earplugs of PPE is needed when operating the saw.
- 29- The oil in use should be void of any poison and danger.
- 30- Before any maintenance the power plug has to be removed from the supply socket.
- 31- **WARNING:** Attach all protective parts before operating this saw.

- ing the cut. Keep blade guide arm tight. A loose blade guide arm will affect sawing accuracy. Make sure that blade tension and blade tacking are properly adjusted. Recheck blade tension after initial cut with a new blade. To prolong blade life always release blade tension at the end of each workday. Make sure blade speed is set correctly for material being cut.
13. Check coolant daily: low coolant level can cause foaming and high blade temperatures. Dirty or weak coolant can clog pump, cause crooked crust, low cutting rate and permanent blade failure. Dirty coolant can cause the growth of bacteria with ensuing skin irritation.
 14. When cutting magnesium never use soluble oils or emulsions (oil-water mix) as water will greatly intensify any accidental magnesium chip fire. See your industrial coolant supplier for specific coolant recommendations when cutting magnesium.
 15. Stop the machine before removing workpieces.
 16. Make all adjustments with the power off. Before any maintenance the power plug has to be removed from the supply socket.
 17. Disconnect machine from power source when making repairs.
Shut off power and clean the blade saw and work area before leaving the machine. Clear away the waste residue so as to avoid accidental injury after working.
 18. This machine is only used for horizontal metal cutting, not vertical woodworking cutting.

About the safety of optional accessories.

There are two optional safety accessories. Please read in detail from this clause about the safety use of these devices as following.

1. Optional positive mode interlock for pulley cover: if the cutting speed need to be changed very often, you must choose this option.
2. Optional handle operated power disconnection device: if your machine is equipped with this option, please disconnect power through this device for some situation. Otherwise, disconnect power according to the instruction in the clause of operation.

Environment Requirements for Installation.

1. Be sure to provide sufficient light for operation according to the codes or regulations published for local area. If you do not get the information about lighting, a light intensity of 300 Lux is the least value to be supplied.
2. The place where machine install must be flat and big enough for the operation.

Noise Level

1. The noise level of this machine is about 75 db(A) during operation.
2. While taking provisions for the risk of noise, the noise level of working environment should be taken into consideration also.

Handling & Transportation of Machine

1. The total weigh of this machine must be ensured before handling.
2. This machine can not be handled without help of lifting tools.

Transportation Methods

WARNING

1. Always keep balance of the machine in transportation. Watch the gravity!
2. Drive forklift slowly and carefully.

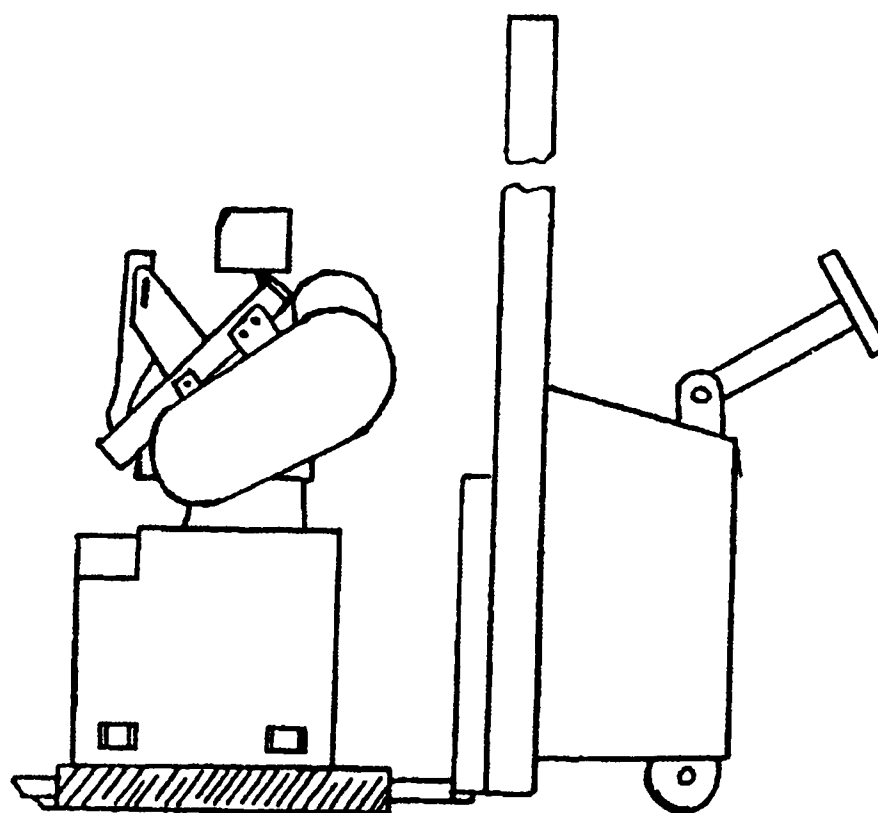

WIRING DIAGRAM

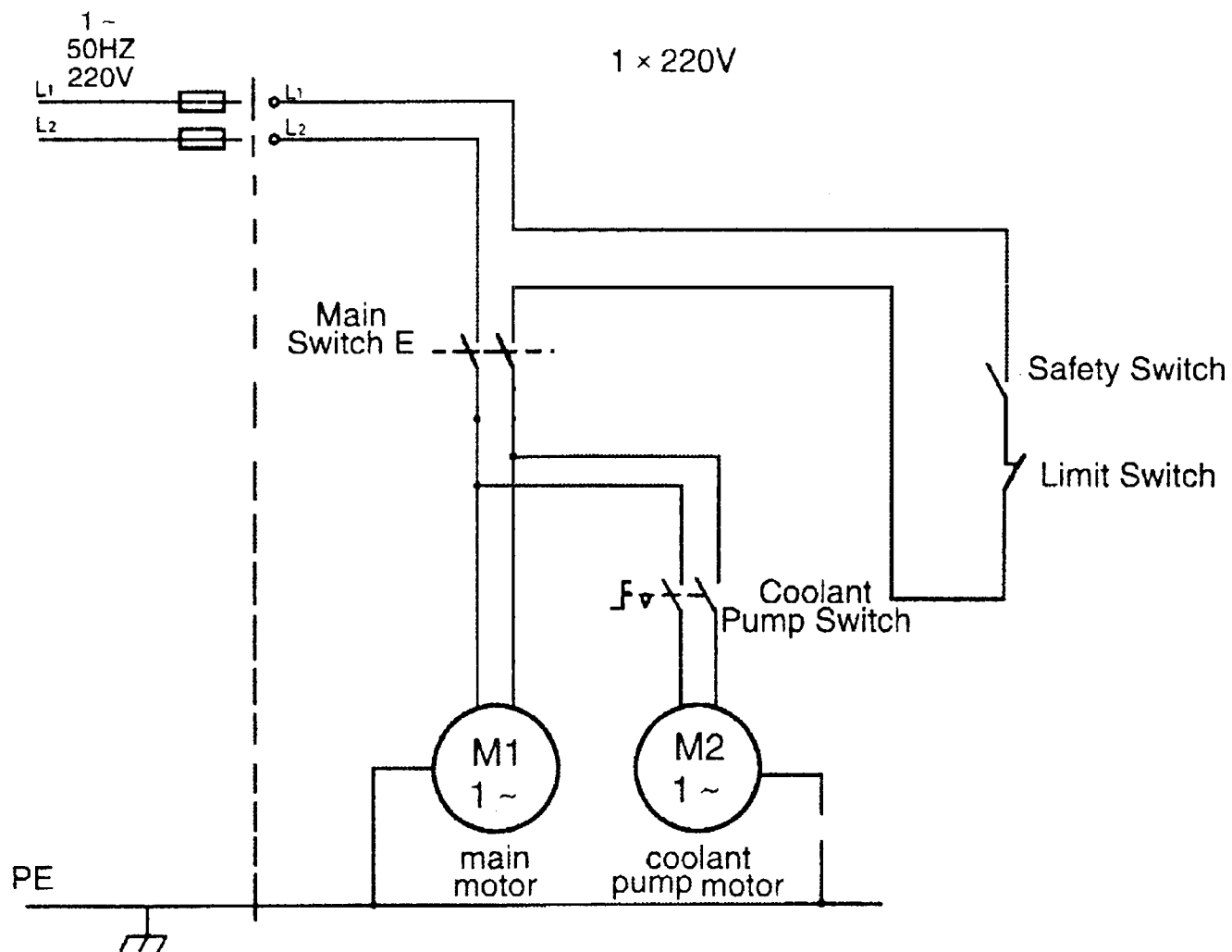
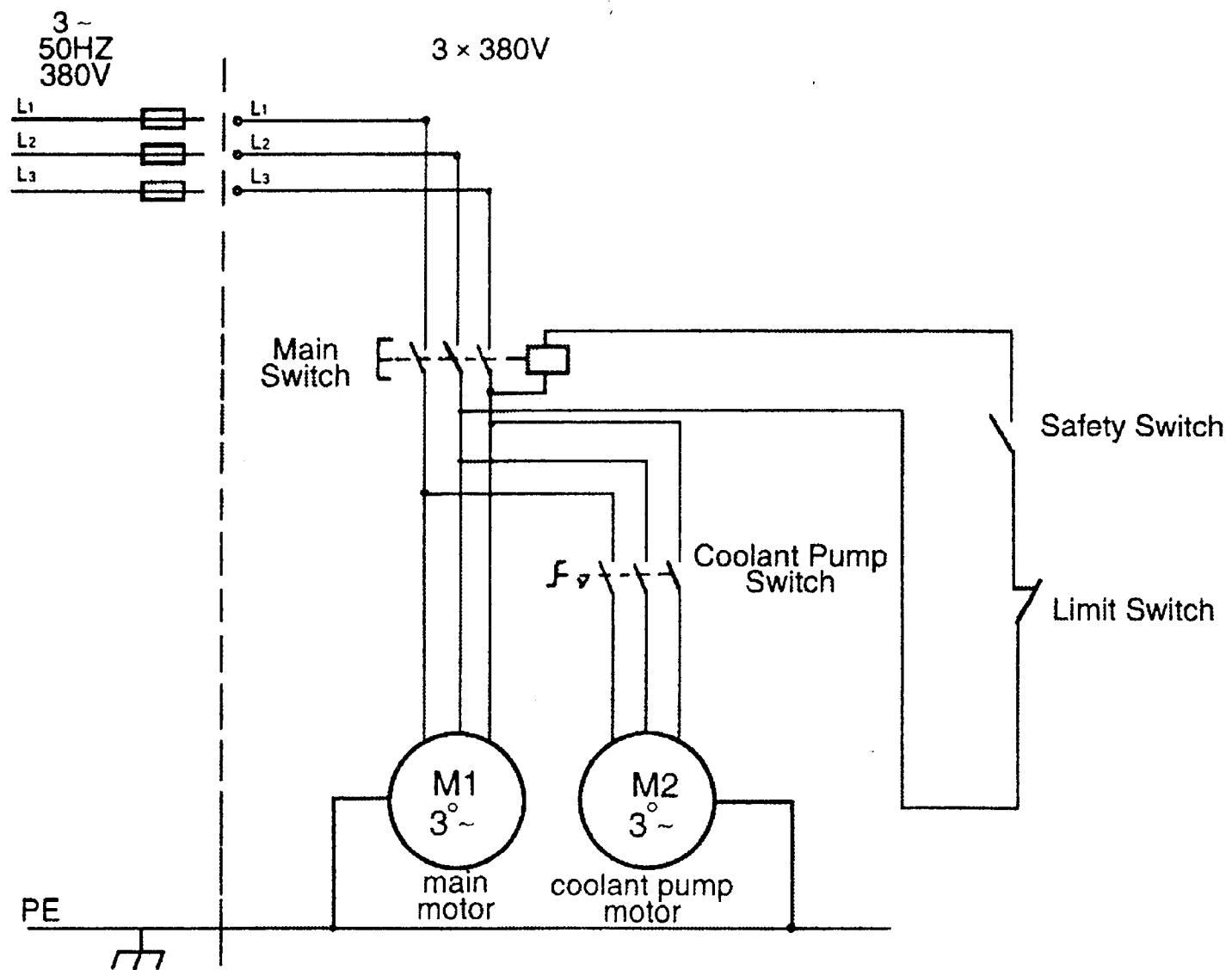

Grounding:

The grounding of this model is carried out by connecting the yellow/green terminal of supply cable to the grounding terminal of power source. Be sure to ground your machine before connecting machine to power source in any situation.

WARNING!

Do not disconnect grounding terminal before disconnecting power source.

Specifications

Cutting Capacity	7"Round 7" × 12"Rectangle
Blade speeds	34-41-59-98MPM50HZ 41-49-69-120MPM60HZ
Blade size	3/4" × 0.032 × 93"

Unpacking and clean-up

1. Finish uncrating the saw. Inspect it for shipping damage. If any damage has occurred, contact your distributor.
2. Unbolt the saw from the skid and place it on a level surface.
3. Clean rust protected surfaces with kerosene, diesel oil, or a mold solvent. Do not use cellulose-based solvents such as paint thinner or lacquer thinner. These will damage painted surfaces.

Assembly

1. Place blocking under the ends of the saw base to allow wheel installation. **Caution:** Make sure saw is steady while temporarily supported.
2. Slide wheel axles through holes in base.
3. Slide wheels onto axles and fasten with pins. Bend pins to hold in place. (Fig. 1)
4. Slide material stop bar (1, Fig. 2) into base, then take out nut and washer to tighten the bar (1). slide material stop (2) onto bar and tighten bolt (3).
5. Slide cylinder bar (1, Fig. 3) into base and tighten. slide cylinder (3) onto bar and tighten nut (4). slide the screw (2) into the cylinder and tighten.
6. Remove transportation strap and keep for later use should the saw be moved any distance.

Coolant Tank Preparation

WARNING

Disconnect bandsaw from the power source before making any repairs or adjustments!

Failure to comply may cause serious injury!

Use of a water-soluble coolant will increase cutting efficiency and prolong blade life. Do not use black cutting oil as a substitute. Change cutting oil often and follow manufacturers instructions as to its uses and precautions.

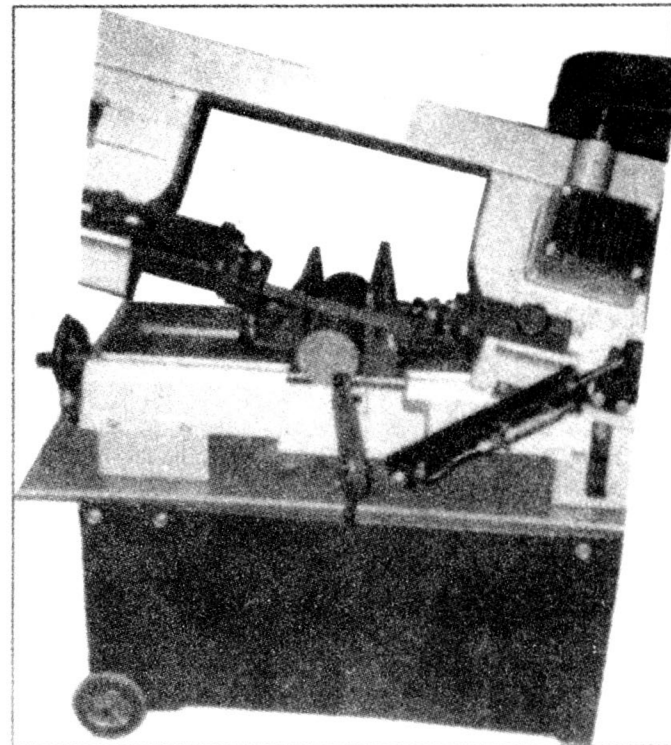

Fig.1

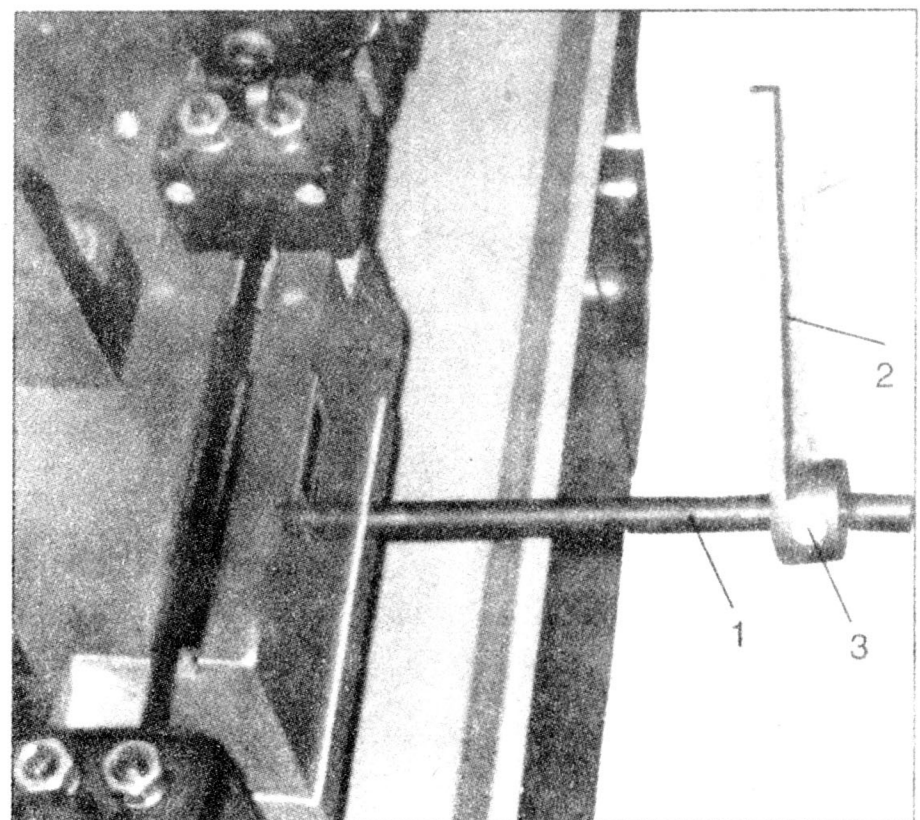

Fig.2

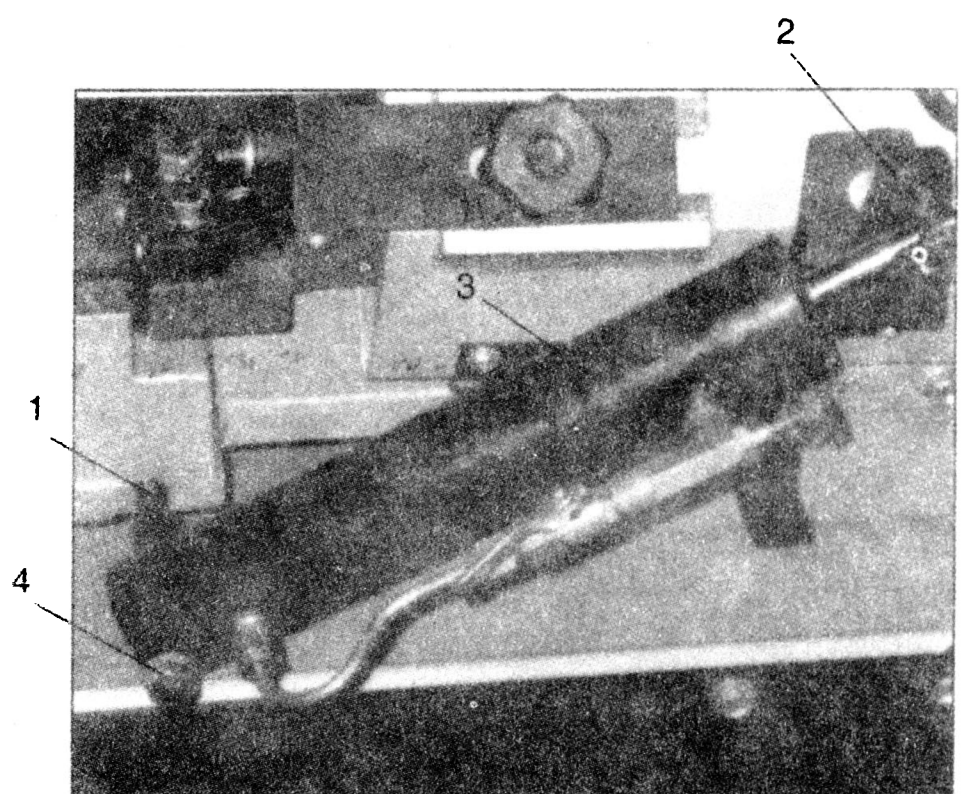

Fig.3

1. Disconnect machine from the power source.
2. Remove coolant return hose from tank cover.
3. Slide tank out of saw base and carefully remove lid containing coolant pump.
4. Fill tank to approximately 80% of capacity.
5. Place lid back onto tank and place tank assembly back into base.
6. Replace return hose back into hole in tank lid.

Hydraulic feed selector operation

The hydraulic feed selector is used to control the blade feed rate and to lock the arm in the vertical position. To increase the feed rate, turn knob (1, Fig.4) counter-clockwise. To decrease the feed rate, turn knob (1) clockwise. To turn off the flow of hydraulic fluid, turn lever as in figure 4. to turn the hydraulic cylinder on, raise lever (2) to position.

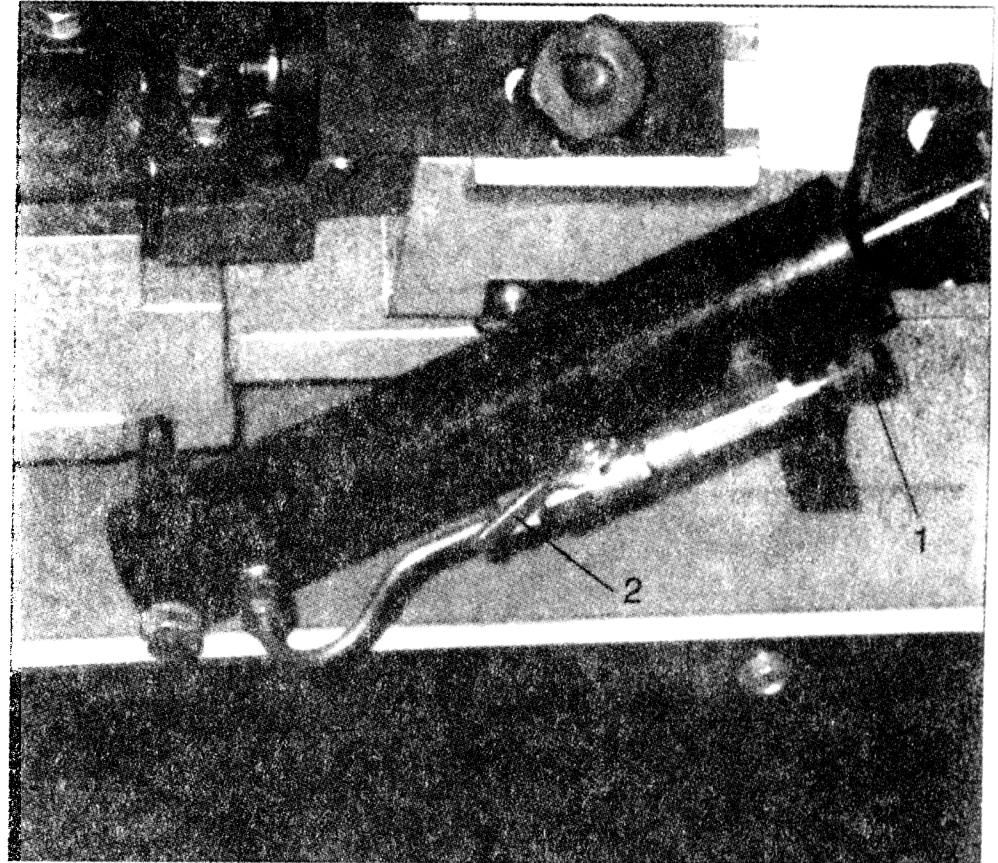

Fig.4

Prior to operation

1. Check to see blade tooth direction matches diagram on saw body.
2. Check to see that blade is properly seated on wheels after proper tension has been applied.
3. Set blade guide roller bearings snug against blade. See "adjusting blade guide bearings" for more detail.
4. Check for slight clearance between back up rollers and back of blade.
5. Position both blade guides as close to work as possible.
6. Select proper speed and feed rate for material being cut.
7. Material to be cut must be held securely in vise.
8. Check to see that coolant level is adequate.
9. Do not start cut on a sharp edge. File it off first.
10. Keep machine lubricated. See "lubrication" section.

Changing blade speed

1. Disconnect machine from the power source.
2. Loose motor plate lock bolt (1, Fig.5).
3. Loose motor plate slide bolt (2) until belt can be moved on the pulleys.
4. Move belt to the desired pulley combination.
5. Tighten motor plate slide bolt (2) to re-tension belt.
6. Tighten motor plate lock bolt (1).
7. Connect machine to the power source.

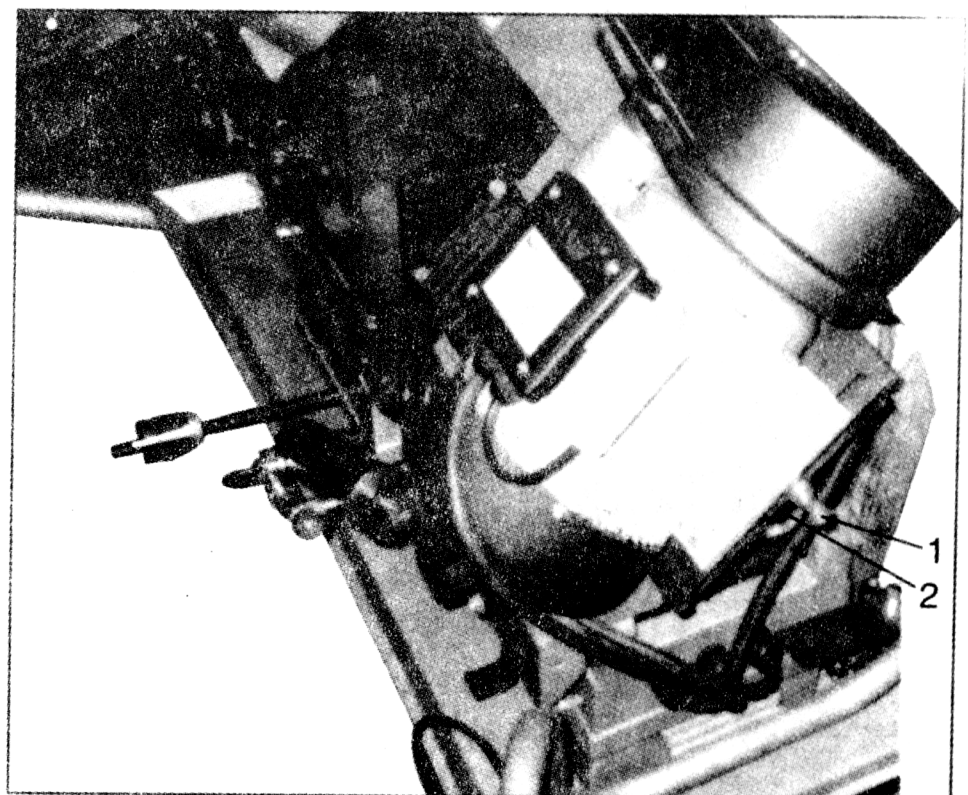

Fig.5

Adjusting Blade Guides

1. Disconnect machine from the power source.
2. Loosen knob (1, Fig. 6) and knob (2). Slide blade guide assemblies as close as possible to the material without interfering with the cut.
3. Tighten knob (1) and knob (2) and connect machine to the power source.

Vise Adjustment



WARNING

Do not make any adjustments or load/unload material from vise while machine is running!

Failure to comply may cause serious injury!

To set the vise for 0 to 45 degree cutting:

1. Remove bolt and nut assemblies (C, Fig.7).
2. Position vise and re-install as pictured in Fig.8. Pay particular attention to bolt hole location.
3. Set vise to desired angle, re-install nuts and bolts, and tighten nut and bolt assemblies.
4. Adjust movable vise parallel to fixed vise by loosening bolt (A, Fig.8), adjusting to parallel, and tightening bolt.

To set vise for maximum width of stock cutting:

1. Remove nut and bolt assemblies.
2. Position vise and re-install bolt assemblies as pictured in Fig. 7.

Adjusting Blade Tension



WARNING

Disconnect machine from the power source!

Blades are sharp! Use extra care when removing, installing or adjusting!

Failure to comply may cause serious injury!

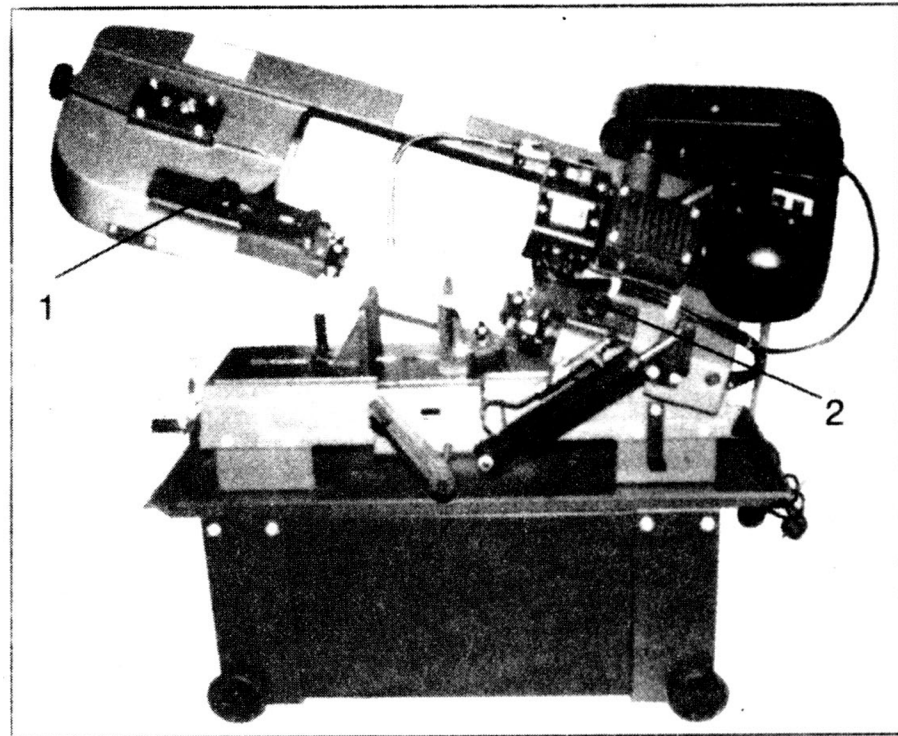

Fig.6

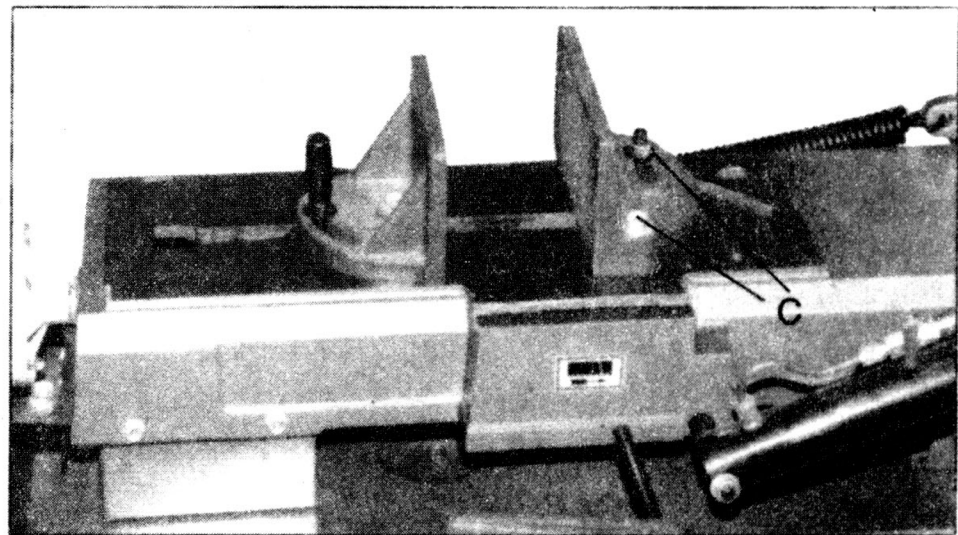

Fig.7

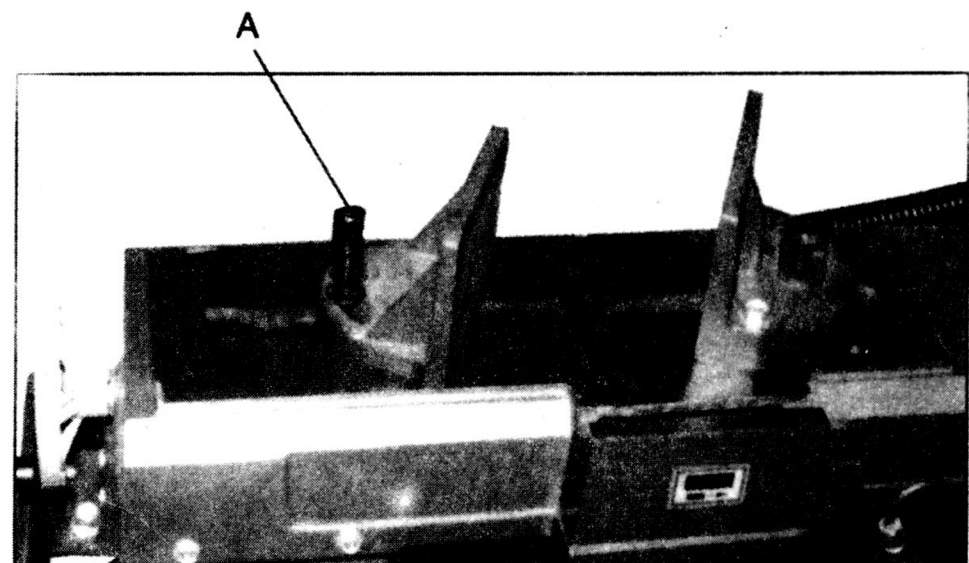

Fig.8

Blade tension is important to the proper operation of the saw. Proper blade tension is 700 to 900 kgs lbs. per square inch as measured on a blade tension gauge.

To set the blade tension without the use of a blade tension gauge:

1. Install blade between wheel and insert blade between bearings on blade guides.
2. Tension blade slightly to remove any sag in blade between blade wheels.
3. Turn blade tension knob (A, Fig.9) one and three quarter to two revolutions clockwise. This equals approximately 800kgs. of blade tension.

CAUTION!

Do not over tighten blade. This may cause blade to stretch and warp.

4. After blade has been completely installed, close covers, connect to the power source, and run saw for two to three minutes so blade can seat properly.
5. Disconnect machine from the power source. Open cover and loosen blade just until it being to sag.
6. Tighten blade until it becomes straight between blade wheel and all sag has been eliminated.
7. Tighten blade by turning blade tension wheel two full revolutions. Blade is now properly tensioned and ready for use.
8. Close covers and connect machine to the power source.

Changing Blades



WARNING

**Never operate this saw unless all blade guards are installed and in proper working order!
Never adjust blade brush while machine is running!
Failure to comply may cause serious injury!**

CAUTION!

This machine is designed and intended for use with blades that are 19mm wide by 0.9mm thick by 2360mm long. Use of blades with different specifications may cause inferior performance.

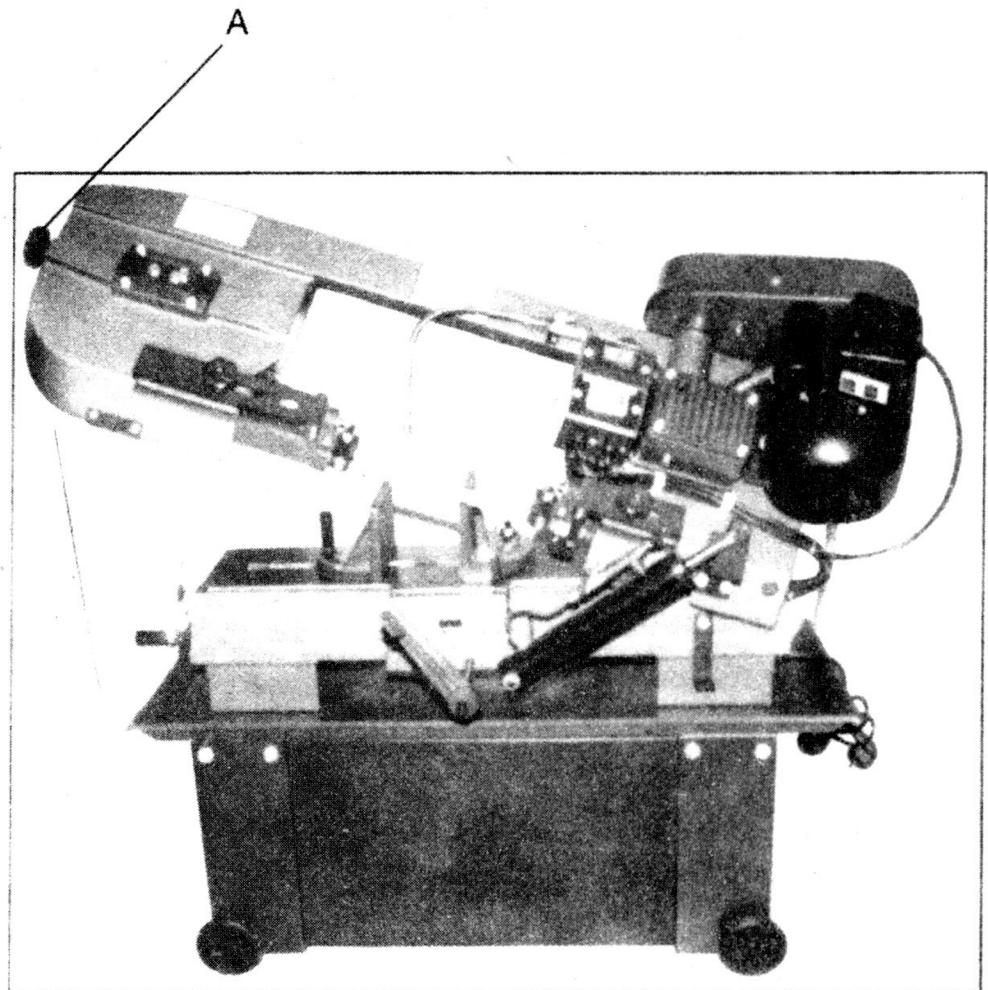

Fig.9

1. **Disconnect machine from the power source.**
2. Raise saw arm to vertical position and lock in place by turning hydraulic cylinder off.
3. Remove red blade guard assembly (A, Fig.10) by removing two screws (B).

⚠ WARNING

**It is essential this guard be installed after the new blade has been fitted!
Failure to comply may cause serious injury!**

4. Remove brush assembly (C) by removing two screws (D).
5. Loosen blade tension by turning blade tension knob counter-clockwise.
6. Carefully remove old blade. **Caution: blade teeth are sharp. Handle with care.**
7. Install new blade by placing blade between blade guides first. Make sure blade teeth face the same direction as indicated on the label found on the saw arm.
8. Place blade around both wheels. Make sure the blade edge rests near the wheel flange on both wheels.
9. Turn blade tension knob clockwise to tension blade. Do not over tension. See section titled "Adjusting Blade Tension".
10. Close blade cover door and secure with lock knobs.
11. Attach red blade guard and brush assembly.
12. Connect machine to the power source.
13. Run saw and make sure blade is tracking properly.

Adjusting Blade Square to Table

1. Disconnect machine from the power source.
2. Place machinist's square on table next blade as pictured in Fig. 11.
3. Check to see blade makes contact with square along the entire width of the blade.
4. If adjustment is necessary, loose bolts (A, Fig, 11) and rotate blade guide assemblies slightly in the same direction until blade makes contact with the square along it's entire width.
5. Tighten bolts (A).
6. Connect machine to the power source.

Note: if adjustment to square blade to table is necessary, be sure to check blade adjustments again.

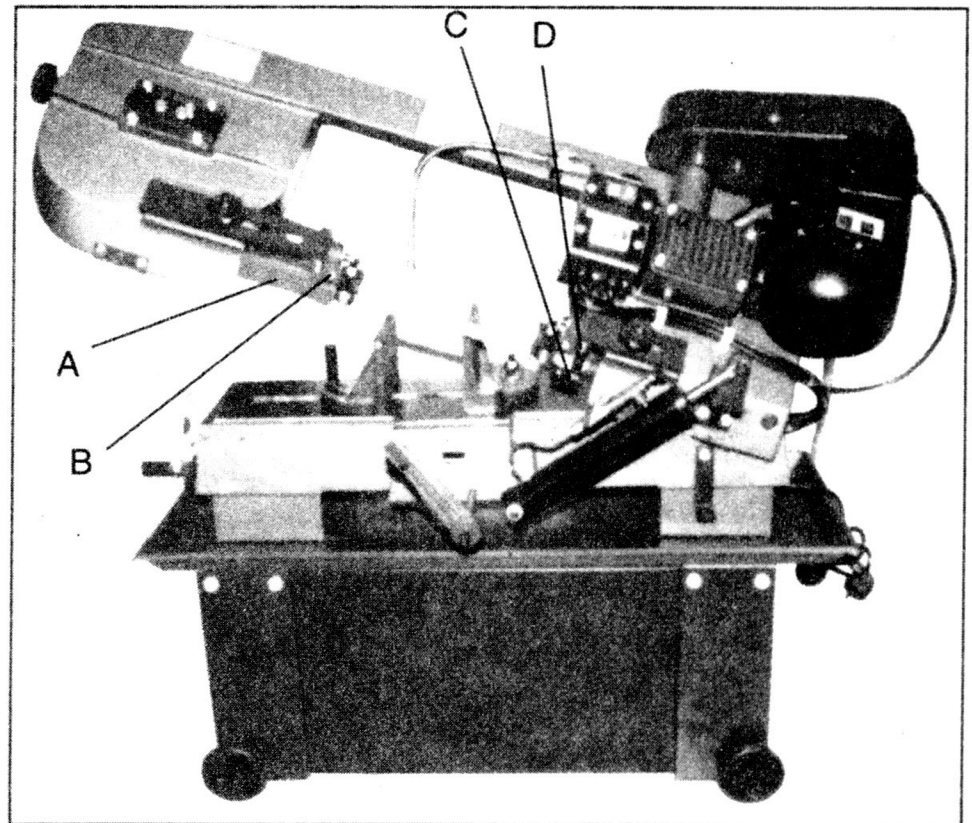

Fig.10

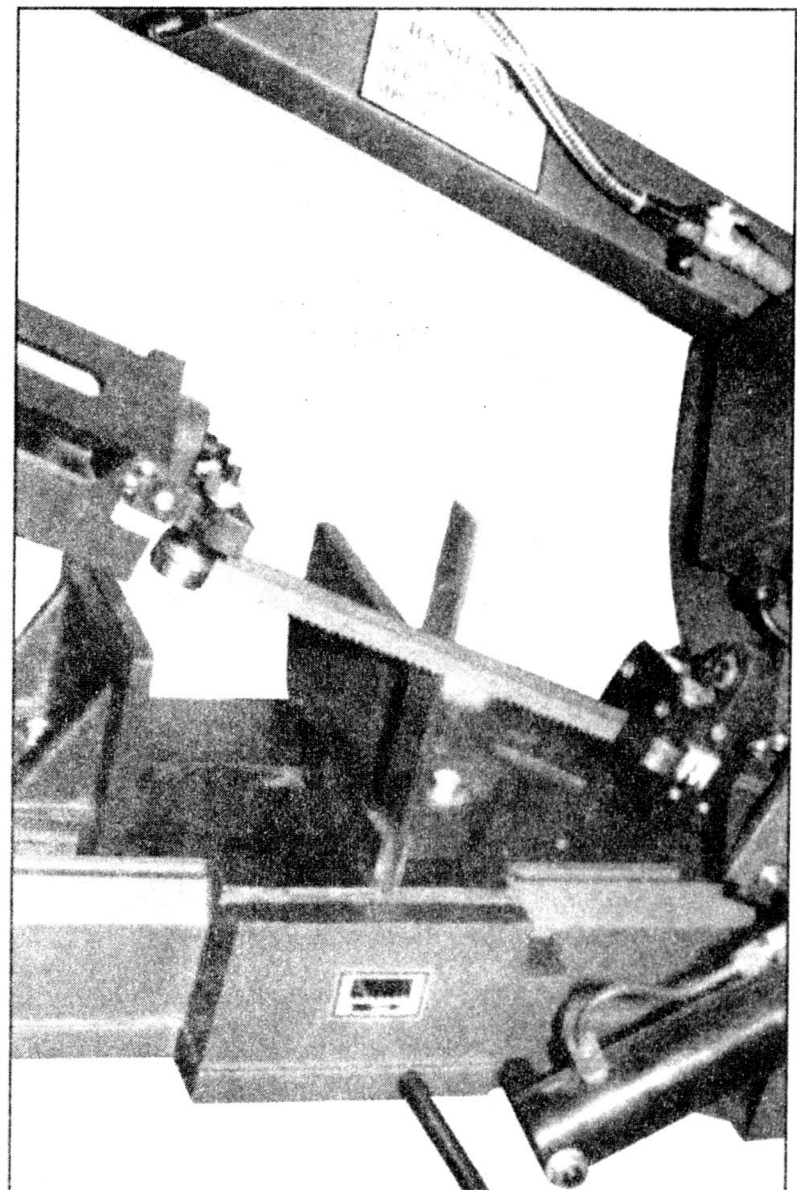

Fig.11

Adjusting Blade Square to Vise

1. Disconnect machine from the power source.
2. Place a machinist's square as pictured in figure 12 square should lie along entire length of vise and blade without a gap.
3. If adjustment is necessary, loosen bolts holding vise and adjust vise so that square lines up properly. Tighten bolts.
4. Connect machine to the power source.

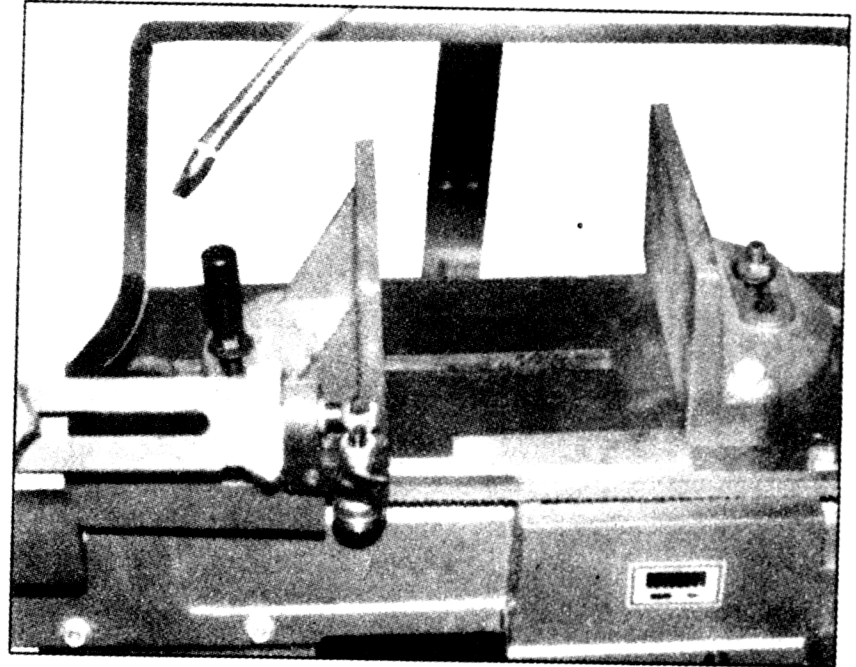

Fig.12

Adjusting Blade Tracking



WARNING

**Blade tracking adjustment requires running the saw with the back cover open. This adjustment must be completed by qualified persons only!
Failure to comply may cause serious injury!**

Note: Before making any tracking adjustments, try a new blade. Warped blades will not track.

Blade tracking has been set at the factory and should not require adjustment. If a tracking problem occurs, adjust the machine as follows:

1. Move saw arm to the vertical position and lock in place by shutting off the hydraulic cylinder valve.
2. Confirm that blade tension is set properly. To adjust, see section titled "Adjusting Blade Tension".
3. Open back cover by loosening lock screws.
4. Run saw and observe blade. Blade should run next to but not tightly against wheel flange.
5. Loosen bolts (A, Fig.13).
6. Turn set screw (B) while observing blade tracking on wheel. Turn set screw clockwise to track blade closer to the wheel flange. Turn set screw counter-clockwise to track blade away from the wheel flange.
7. Once tracking is set, tighten bolts (A).

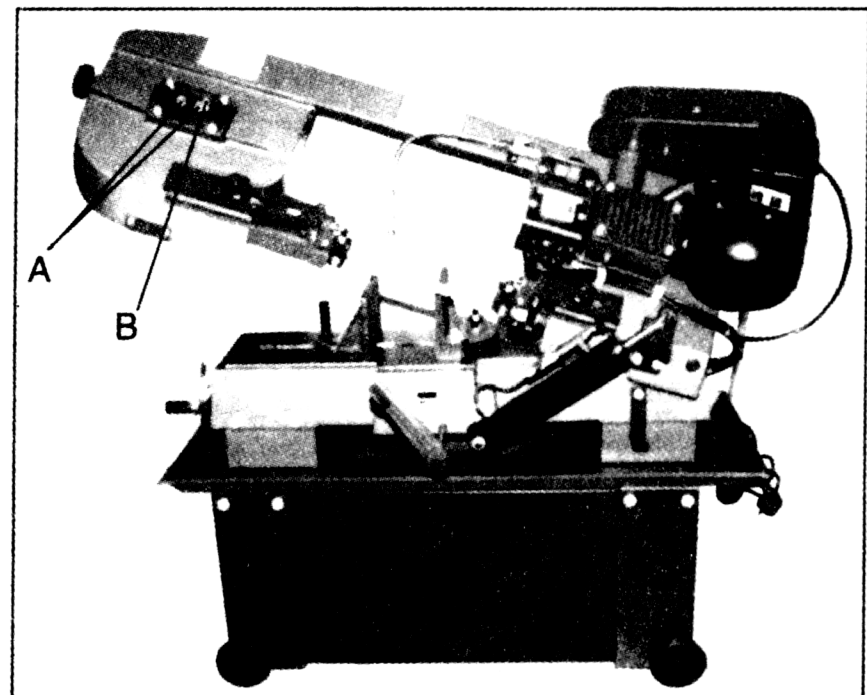

Fig.13

Adjusting Blade Guide Bearings

CAUTION!

This machine is designed and intended for use with blades that are 19mm wide by 0.9mm thick by 2360mm long. Use of blades with different specifications may cause inferior Performance.

1. Disconnect machine from the power source.
2. Raise arm to vertical position and lock in place by turning off the hydraulic cylinder valve.
3. Loosen hex cap screw (A, Fig. 14) and adjust assembly so that back roller bearing is approximately 0.08mm~0.12mm from the back of the blade.
4. Turn nut (B) to adjust eccentric bearing snug to the blade. Blade should still move up and down freely when grasped as in Fig. 15.
Warning! Make sure power is disconnected and hands are protected before handling blade. Be sure that blade teeth do not interfere with the roller bearings:
5. Repeat for other blade guide assembly.
6. Connect machine to the power source.

Adjusting Bow Weight

Bow weight is one of the most important adjustments of the saw. If the bow weight is not set properly, one can expect poor performance, crooked cuts, tooth stripping, stalling, and the blade popping off the blade wheels. The hydraulic feed rate unit will not compensate for improper bow weight. Bow weight has been set at the factory and should not need adjustment. If adjustment is necessary:

1. Disconnect machine from the power source.
2. Turn hydraulic cylinder valve on and place saw arm in horizontal position.
3. Turn feed rate valve on hydraulic cylinder counter-clockwise until it stops.
4. Place a fish-type scale under blade tension handle and lift the saw arm. Scale should indicate approximately 5-6 kg.
5. Adjust tension to approximately 5-6 kgs. By turning bolt (A, Fig.16).
6. Connect machine to the power source.

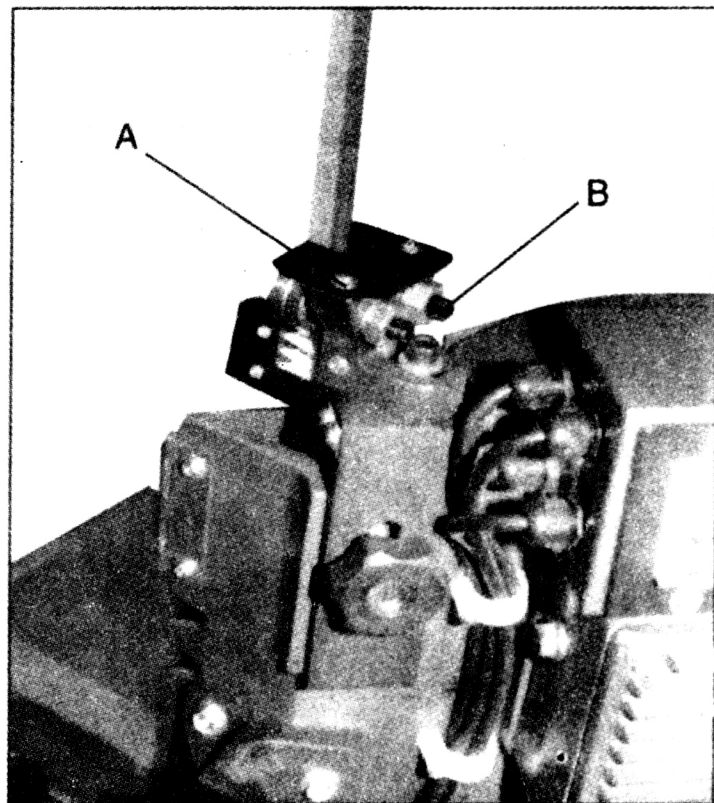

Fig.14

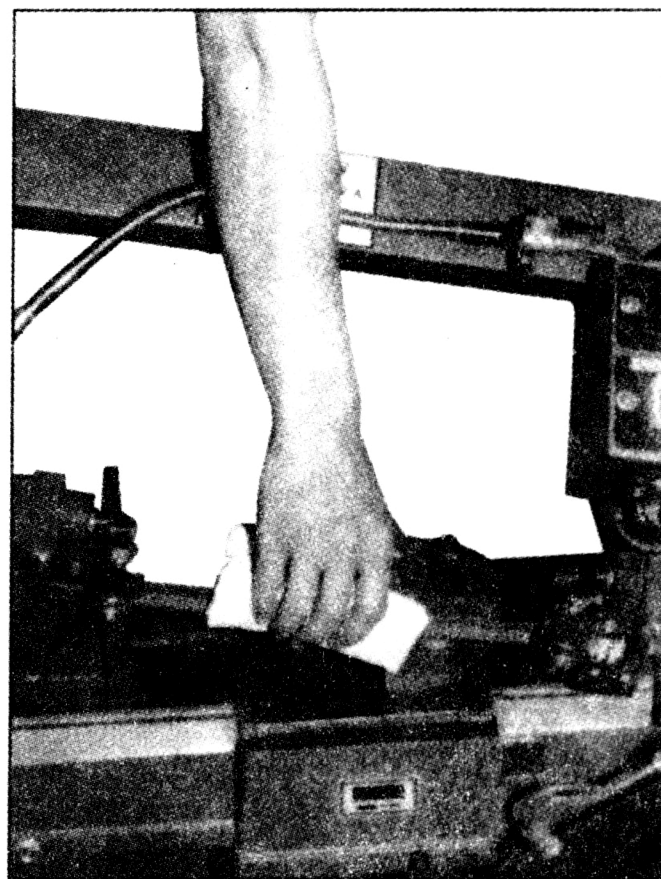

Fig.15

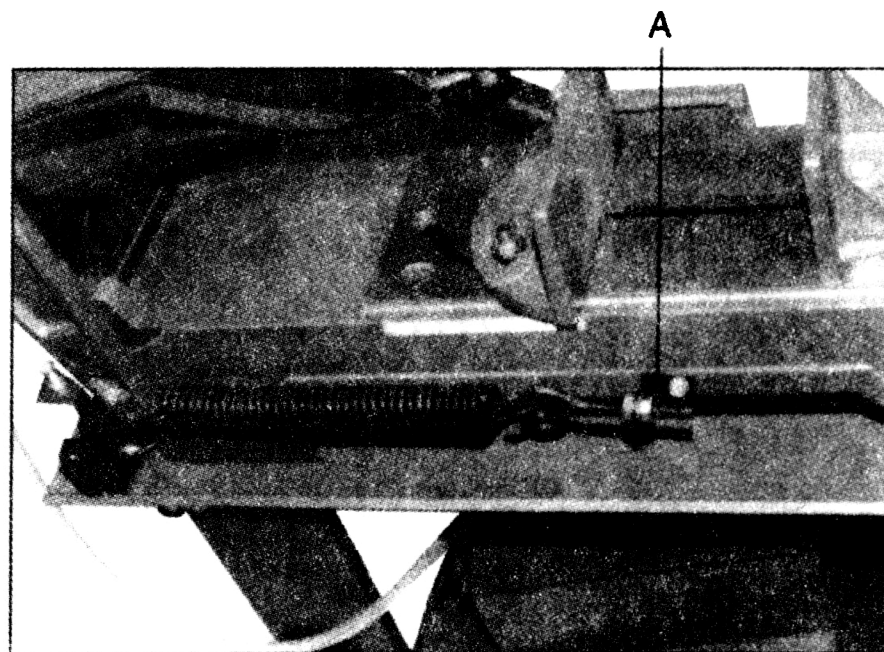

Fig.16

Lubrication

Ball bearings on the blade guide assemblies and the blade wheels are permanently sealed and require no lubrication.

Lightly lubricate vise screw with #2 tube grease.

Change gear box oil after the first 90 days of operation. There after, change every six months.

To change gear box oil:

1. Disconnect machine from the power source.
2. Place saw arm in the horizontal position.
3. Remove screws (A, Fig. 17) from the gearbox and remove cover plate and gasket.
4. Draw off the oil from gearbox.
5. Place the saw arm in the horizontal position again. Wipe out remaining oil with a rag.
6. Fill gearbox with approximately 0.3liter of 90 weight gear oil.
7. Replace gasket and cover. Fasten cover with screws.
8. Connect machine to the power source.

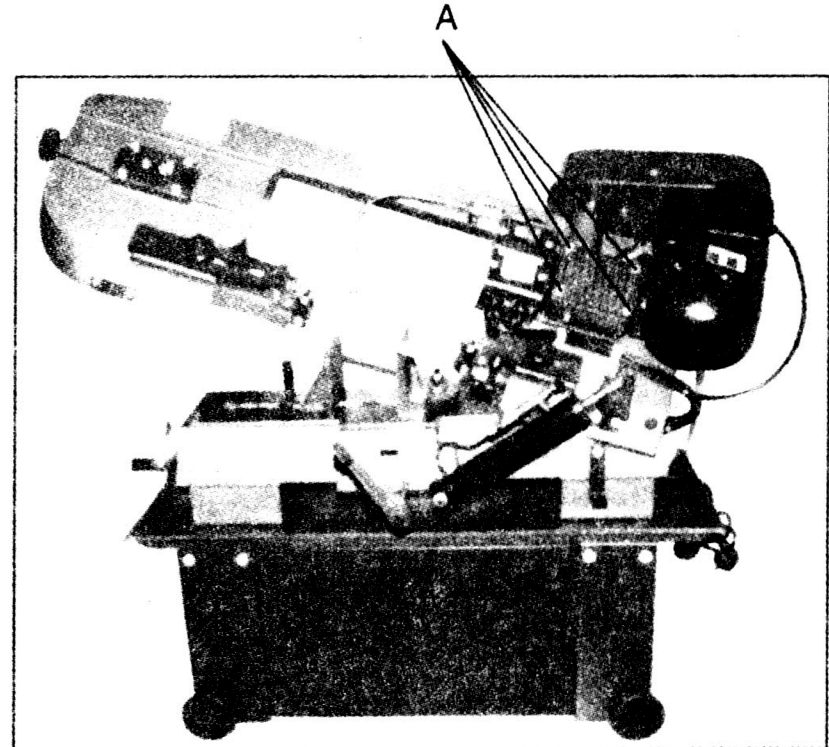

Fig.17

Maintenance

WARNING

**Disconnect machine from the power source before making any repair or adjustment!
Failure to comply may cause serious injury!**

1. Keep all surfaces clean and free and free of rust, slag, chips, and coolant build-up.
2. Do not use compressed air to clean bandsaw. Compressed air may force chips into the guide bearings and other critical areas of the saw.
3. Use a small paintbrush or parts cleaning brush to remove metal particles.
4. Wipe saw down with a clean, dry cloth and oil all unpainted surfaces with light machine oil.
5. Keep blade guides clean and free of metal chips.
6. Check guide bearings frequently to make sure they are properly adjusted and turning freely.

Chip cleaning brush

WARNING!

Do not attempt to adjust blade brush with the machine running! Adjust only when the machine's power cord has been removed from the power source!

Failure to comply may cause serious injury!

It is important that the blade cleaning brush be properly adjusted and kept in good working order. Replace the brush if it becomes damaged or worn out. Blade life will be shortened severely if the brush is allowed to go out of adjustment, becomes damaged, or is worn out.

ROUBLE SHOOTING CHART

SYMPTOM	POSSIBLE CAUSE (S)	CORRECTIVE ACTION
Excessive blade breakage	<ol style="list-style-type: none"> 1. Incorrect blade tension 2. Incorrect speed or feed 3. Material loose in vise 4. Blade rubs on wheel flange 5. Teeth too coarse for material 6. Teeth in contact with work before saw is started 7. Misaligned guides 8. Blade too thick for wheel diameter 9. Cracking at weld 	<ol style="list-style-type: none"> 1. Adjust to where blade just does not slip on where 2. Check machinist handbook 3. Clamp work securely 4. Adjust wheel alignment 5. Check machinist handbook for recommended blade type 6. Place blade in contact work after motor is started 7. Adjust 8. Use thinner blade 9. Make longer annealing cycle
Premature blade dulling	<ol style="list-style-type: none"> 1. Teeth too coarse 2. Too much speed 3. Inadequate feed pressure 4. Hard spots or scale in/on material 5. Work hardening of material (especially stainless steel) 6. Blade installed backwards 7. Insufficient blade tension 	<ol style="list-style-type: none"> 1. Use finer tooth blade 2. Try next lower speed 3. Decrease spring tension on side of saw 4. Reduce speed increase feed pressure (scale) increase feed pressure (hard spots) 5. Increase feed pressure by reducing spring tension 6. Remove blade twist inside out and reinstall blade 7. Increase tension to proper level
Bad cuts (crooked)	<ol style="list-style-type: none"> 1. Work not square 2. Feed pressure too great 3. Guide bearing not adjusted properly 4. Inadequate blade tension 5. Blade guides spaced out too much 6. Dull blade 7. Speed incorrect 8. Blade guide bearing assembly loose 9. Blade guide bearing assembly loose 10. Blade tracks too far away from wheel flanges 	<ol style="list-style-type: none"> 1. Adjust vise to be square with blade always clamp work tightly in vise 2. Reduce pressure by increasing spring tension on side of saw 3. Adjust guide bearings to 001 greater than max, thickness, including weld of the saw 4. Increase blade tension a little at a time 5. Move guides as close to work as possible 6. Replace blade 7. Check manual for recommended speeds 8. Tighten 9. Tighten 10. Retrace blade according to operating instructions
Bad cuts (rough)	<ol style="list-style-type: none"> 1. Too much speed or feed 2. Blade is too coarse 	<ol style="list-style-type: none"> 1. Reduce speed and feed 2. Replace with finer blade
Unusual wear on side/back of blade	<ol style="list-style-type: none"> 1. Blade guides worn 2. Blade guide bearings not adjusted properly 3. Blade guide bearing bracket is loose 	<ol style="list-style-type: none"> 1. Replace 2. Adjust as per operators manual 3. Tighten
Feeth ripping from blade	<ol style="list-style-type: none"> 1. Tooth too coarse for work 2. Too heavy feed; too slow feed 3. Vibrating work piece 4. Gullets loading 	<ol style="list-style-type: none"> 1. Use finer tooth blade 2. Increase feed pressure and /or speed 3. Clamp work securely 4. Use coarse tooth blade or brush to remove workpieces
Motor running too hot	<ol style="list-style-type: none"> 1. Blade tension too high 2. Drive belt tension too high 3. Blade is too coarse for work (pipes especially) 4. Blade is too fine for work (heavier, soft material) 5. Gear not aligned properly 6. Gears need lubrication 7. Idler wheel needs lubrication 	<ol style="list-style-type: none"> 1. Reduce tension on blade 2. Reduce tension on drive belt 3. Use finer blade 4. Use coarser blade 5. Adjust gears so that worm is in center of gear 6. Check oil bath 7. Oil bearing/shaft on idler wheel

part number	description	size number	qty	part number	description	size number	qty
1	TABLE		1	106	GEAR BOX GASKET		1
2	ACME SCREW		1	107	KEY	6X6X20	1
3	WASHER	Φ16	1	108	WORM GEAR		1
4	HEX.SOC.SET.SCREW	M8x12	1	109	TRANSMISSION SHAFT		1
5	WHEEL		1	110	C-RING 8		1
6	HEX.HD.SCREW	M10x40	1	111	KEY	6X6X20	1
7	WASHER	Φ10	2	112	BUSHING		1
8	WISE JAW BRACKET(FRONT)		1	113	BEARING	180205	1
9	BRACKET		1	114	BEARING BUSHING		1
10	HEX.SOC.SCREW	M10x40	1	115	BEARING	180205	1
11	HEX.NUT	M12	1	116	BEARING COVER		1
12	WASHER	Φ12	1	117	HD.SCREW	M4X8	3
13	CARRIAGE BPLT		1	118	BODY FRAME		1
14	HEX.HD.SCREW	M10x40	1	119	SPRING WASHER	Φ10	4
15	WISE JAW BRACKET(REAR)		1	120	HEX.HD.SCREW	M10X40	4
16	BUSHING		1	121	CRING		1
17	SUPPORT ROD		1	122	BLADE WHEEL(REAR)		1
18	HEXAGON BOLT	M8X20	1	122-1	ACTIVE SAW WHEEL		1
19	PIVOT BRACKET		1	123	HEXAGON BOLT	M8X20	1
20	WASHER		1	124	PIN	4x25	1
21	HEX.HD.SCREW	M10X40	2	125	SLIDING BRAW SLOCK		1
22	SUPPORT PLATE		1	126	BLSDE WHEEL SHAFT(FRONT)		1
23	SPRING		1	127	SLIDING GUIDES PLATE		2
24	SPRING ADJUSTING ROD		1	128	BLADE TENSION SLIDING BLOCK		1
25	SPRING HANDLE BRACKET		1	129	HEXAGON SOCKET SCREW	M8X40	1
26	HEX.HD.SCREW	M8X16	1	130	HEXAGON SOCKET SCREW	M8X40	2
27	WASHER	Φ8	1	131	SPRING WASHER	Φ8	2
28	HEX.NUT	M10	1	133	HEX.HD.SCREW	M8X16	4
29	WASHER	Φ10	1	134	SPRING		1
30	HEX.SOC.SET.SCREW	M8X12	1	135	BLADE ADJUSTABLE KNOB		1
31	STOCK STOP ROD		1	136	BEARING BUSHING		1
32	STOP BLOCK		1	137	CRING	B35	1
33	HEX.HD.SCREW	M8X30	1	138	BEARING	6202Z	2
34	WASHER	Φ8	1	139	BLADE WHEEL(FRONT)		1
35	SUPPORT PLATE		1	139-1	BEARING CAP		1
36	SUPPORT PLATE		1	139-2	HD.SCREW	M4X8	3
37	HEX.HD.SCREW	M10X30	1	140	BLADE	2360X20X0.9	1
38	HEX.NUT	M10	1	141	WASHER	Φ8	1
39	HEX.HD.SCREW	M8X16	2	142	HEX.HD.SCREW	M8X16	1
40	WASHER	Φ8	2	143	SWITCH HIP		1
41	HEX.HD.SCREW	M8X30	1	144	WASHER	Φ6	1
42	HEX.NUT	M8	1	145	ROUND HD.SCREW	M6X16	1
43	HEX.HD.SCREW	M8X16	2	145-1	SPRING WASHER 6		5
44	WASHER	Φ8	2	146	NOZZLE COCK SUPPORT		1
45	ELECTRICAL BOX		1	146-1	JOINT		1
46	SWITCH		1	146-2	WATER PIPE HEAD		1
47	COVER		1	147	ROUND HD.SCREW	M6X12	2
49	TOGGLE SWITCH		1	148	TAHE THE BOLT	M10X35	2
50	WIRE RETAINER		1	149	ADJUSTABLE BRACKET(REAR)		1
51	COOLANT PAN		1	150	HEX NUT	M10X1	4
52	FILTER		1	151	SPRING WASHER	Φ10	4
53	HEX.HD.SCREW	M8X30	8	152	BEARING	80029	2
54	WASHER	Φ8	17	153	BLADE ADJUSTABLE REAR)		1
55	HEX.NUT	M8	8	154	BEARING PIN		2
56	LEG(RIGHT)		1	155	WASHER	Φ8	1
57	LEG(LEFT)		1	156	HEX.SOCK.SCREW	Φ10	2
58	HEX.HD.SCREW	M10X20	8	157	DEFLECTOR PLATE		1
59	WASHER	Φ10	16	158	HD.SCREW	M4X8	3
60	HEX.NUT		8	159	BEARING SHAFT		2
62	LIMIT SWITCH		1	160	ECCENTRIC SHAFT		2
62-3	SPRING WASHER		2	161	BEARING	80029	8
62-4	WASHER 6		5	162	CRING	A10	4
62-5	ROUND HD.SCREW	M6x16	3	163	ADJUSTABLE BRACKET(FRONT)		1
62-6	HEX.NUT	M6	1	164	BEARER CARRIER		2
63	PANEL		1	165	BLADE COVER(FRONT)		1
64	HOSE		1	166	ROUND.HD.SCREW	M6x12	6
65	HEX.HD.SCREW	M8X16	6	167	HEX.SOC.SCREW	M8X25	2
66	WASHER	Φ8	12	168	PLUM SCREW		4
67	HEX.NUT	M8	6	169	BLADE BAC COVER		1
68	COOLANT TANK		1	170	WHEEL COVER		1
69	PUMP SUPPORT		1	171	WASHER	Φ6	10
70	COOLING PUMP		1	172	ROUND HD.SCREW	M6X12	4
71	HEX.HD.SCREW	M4X16	2	173	PLUM SCREW		1
72	WASHER	Φ4	2	174	MOTOR PULLEY COVER		1
73	HEX.NUT	M4	2	176	WASHER	Φ6	2
75	HOSE CLAMP		2	177	HEX.HD.SCREW	M6x16	2
76	HOSE		1	178	KEY	6X6X40	1
77	TUBE FITTING	1/4PT"	1	179	HEX.SOC.SET SCREW	M8X12	1
78	NOZZLE COCK	1/4PTx8'	1	180	MOTOR PULLEY		1
79	WHEEL ROD		2	181	HEX.HD.SCREW	M8X25	4
80	WHEEL		2	182	WASHER	Φ8	8
81	CHECK RING		8	183	MOTOR		1
82	CYLINDER		1	184	HEX.SOC.SCREW	M8XC35	1
83	WASHER	Φ8	3	185	HEX NUT	M8	1
84	HEX.HD.SCREW	M8X25	3	186	MOTOR MOUNT PLATE		1
85	HEX.HD.SCREW		1	187	HEX.NUT	M8	4
87	CYLINDER BRACKET		1	188	HEX.HD.SCREW	M8X16	4
88	SUPPORT ROD		1	189	WASHER	Φ8	4
90	FLAT WASHER	Φ10	1	190	MOTOR MOUNT BRACKET		1
91	HEX NUT	M10	1	191	HEX.NUT	M8	1
92	GEAR BOX		1	192	HEX.HD.SCREW	M8X16	1
93	WORM SHAFT		1	193	HEX.HD.SCREW	M6X12	2
94	KEY	5X5X55	1	194	WASHER	Φ6	2
95	BEARING	6003Z	1	195	SUPPORT PLATE		1
96	BEARING BUSHING		1	196	FLAT GASKET	Φ10	1
97	BEARING	6003Z	2	198	BOLT	M8x12	1
98	CRING	A17	1	205	HEX.HD.SCREW	M6X25	1
99	HEX.SOC.SET.SCREW	M8X12	1	206	BRUSH		1
100	WORM PULLEY		1	207	SELF LOCKING	M6	1
101	HEX.SOC.SET SCREW	MX12	2	208	BRUSH PLATE		1
102	BELT	A650	1	209	FLAT MAT	Φ6	1
103	HEX.HD.SCREW	M6x20	4	210	HEX.NUT	M6	1
104	WASHER	Φ6	4				
105	GEAR BOX COVER		1				

